

Dear **MXL** Owner

Your **MXL Strada / MXL Pista / MXL PRO / MXL PRO 05** is the latest generation of **AIM** data acquisition systems for car / bike racing and provides you a stunning, easy to use and multifunctional display. Not just a stunning fully configurable display to fit all your needs, but also a logger that records yours and your vehicle performances in detail. We offer **MXL** in a wide range of models with different functions and setting. You can choose the exact model to match your needs. **MXL** is part of the **AIM** total data racing solution – which includes our **Race Studio 2** software running on your PC, through which you can control and configure your **MXL** (all versions) as well as download and analyze your data (**Pista / PRO / PRO 05**).

With **MXL** you monitor and display RPM, speed, engaged gear number, lap (split) times and other custom sensors on analog inputs. Depending on **MXL** version you can monitor and record from 8 to 12 analog inputs and display 6 of them. **MXL** has a backlight that can be switched on during night or low light racing too.

In addition you can create track maps with the internal lateral G-force sensor (**Pista / PRO / PRO 05** only) or the external gyroscope (optional BIKE equipment) allowing you to correlate your data to your track position.

Always versatile **MXL** is available with a wide range of non-volatile RAM internal memories> 128kb (**Strada**), 8Mb (**Pista/PRO**) or 16Mb (**PRO 05**). The memory is retained even when power is off.

MXL is equipped with an USB port to interface with a PC. As standard equipment, **MXL Pista / PRO / PRO 05** come with infrared lap transmitter and receiver, that are optional equipment for **MXL Strada**.

Moreover **MXL** is a modular system that, thanks to the CAN bus, can increase its potentialities every day. You can in fact connect it to a wide range of external expansion modules that work as channel multiplier (Data Hub, TC Hub, etc.) as well as to a Lambda Controller, a GPS Laptimer Module and a Video System (DaVid).

Our Technical Support and Customer Service is available every day from 9am to 5pm (call 800.718.9090 in the USA) and, as usual, we are at your side at almost all the major races nationwide, to provide you with personal assistance. If you have any question, need help, or want to give us feedback, please visit our website www.aim-sportline.com (outside USA and Canada), www.aimsports.com (USA and Canada). We are not satisfied until when you are.

Thank you for your choice of an **AIM** product.



Table of contents

1 – MXL KITS	4
2 – HOW TO INSTALL AND POWER MXL	5
3 – HOW TO SAMPLE THE RPM	6
4 – HOW TO INSTALL AND POWER RECEIVER AND TRANSMITTERS	6
4.1 – <i>Infrared receiver</i>	6
4.2 – <i>Infrared transmitters</i>	7
4.2.1 – <i>The lap transmitter</i>	7
4.2.2 – <i>The split transmitter</i>	9
5 – HOW TO CONNECT MXL TO THE ECU	10
6 – HOW TO CONNECT MXL TO THE GPS MODULE	11
7 – HOW TO READ MXL DISPLAY	12
7.1 – <i>MXL alarm led and shift lights</i>	13
7.2 – <i>Forecast Lap time</i>	14
7.3 – <i>Other useful information</i>	15
8 – HOW TO INSTALL RACE STUDIO 2 AND CONFIGURE YOUR MXL	16
8.1 – <i>How to install Race Studio 2 and the USB driver</i>	17
8.1.1 - <i>Race studio 2 installation for Windows XP</i>	18
8.1.2 - <i>Windows XP trouble shootings</i>	18
8.1.3 - <i>Race studio 2 installation for Windows Vista</i>	19
8.1.4 – <i>Windows Vista trouble shootings</i>	20
8.2 – <i>How to configure MXL through Race Studio 2 software</i>	21
8.2.1 – <i>Creating and managing MXL configurations</i>	21
8.2.2 – <i>How to set and select a configuration</i>	23
8.2.3 – <i>How to set MXL Channels</i>	24
8.2.4 – <i>How to set the System Configuration</i>	29
8.3 – <i>How to transmit the configuration</i>	36
8.3.1 – <i>Configuration transmission troubleshooting</i>	37
<i>Note 1: “Race Studio 2” Visualization problems</i>	38



9 – SENSORS MANAGEMENT	42
9.1 – Custom sensor (expert users only).....	42
9.1.1 – How to create a custom sensor	43
9.1.2 – How to modify a custom sensor	44
9.2 – How to calibrate / auto-calibrate a sensor	44
9.2.1 – How to calibrate a Gear sensor (Potentiometer).....	46
9.3 – How to calculate gears	47
9.3.1 – Activate gear calculation proceeding	47
9.3.2 – Learning lap.....	48
9.3.3 - Gear calculation.....	49
9.3.4 - Final suggestions.....	50
10 – WHAT IS ONLINE OPTION	51
11 – MXL KEYBOARD FUNCTION	53
11.1 – How to recall recorded data	53
11.2 – Other keyboard function	54
12 – GPS MODULE AND THE NEW LAP TIMER FUNCTION	56
12.1 – Preliminary operation.....	56
12.2 – How to set GPS beacons	57
12.3 – Additional functions.....	58
12.4 – GPS Manager software.....	59
12.5 – Typical use of GPS Manager software.....	64
13 – MY MXL MEMORY	65
14 – MXL MAINTENANCE	66
15 – HOW TO DOWNLOAD AND SAVE TEST VALUES.....	67
15.1 – How to insert the test in a database.....	70
16 – HOW TO USE RACE STUDIO ANALYSIS (EXCEPT FOR MXL STRADA).....	72
16.1 – How to open a test	73
16.2 – How to plot a channel.....	75
16.3 – How to create a track map (Pista / PRO / PRO 05 only).....	78
16.3.1 – Possible track map creation troubleshooting	81
APPENDIX “A” – INSTALLING THE H ₂ O THERMO RESISTOR	82
APPENDIX “B” – INSTALLING THE EGT THERMOCOUPLE.....	83



APPENDIX “C” – INSTALLING THE “CAR” SPEED SENSOR85

APPENDIX “D” – INSTALLING THE “BIKE” SPEED SENSOR86

APPENDIX “E” – MXL STRADA TECHNICAL CHARACTERISTICS87

APPENDIX “F” – MXL PISTA TECHNICAL CHARACTERISTICS90

APPENDIX “G” – MXL PRO TECHNICAL CHARACTERISTICS93

APPENDIX “H” – MXL PRO 05 TECHNICAL CHARACTERISTICS.....96



1 – MXL Kits

AIM has developed different **MXL** kits to fit various situations; the chart below shows the standard equipment in each kit. All **MXL** kits are designed to be ready for race day, without any extra gear needed to get started:

MXL Strada	MXL Pista	MXL PRO/MXL PRO 05
<ul style="list-style-type: none"> • MXL Strada • CAN/RS232 Cables • Power Cable • Race Studio 2¹ • USB cable 	<ul style="list-style-type: none"> • MXL Pista • CAN/RS 232 Cables • Harness • 2 Temp. sensors • Speed sensor • RPM Sensor + cable • IR Lap Rx and Tx • USB cable • Race Studio 2 	<ul style="list-style-type: none"> • MXL PRO/ PRO 05 • CAN/RS232 Cable • 2 Temp. sensors • Speed sensor • RPM Sensor + cable • IR Lap Rx and Tx • USB cable • Race Studio 2

OPTIONAL EQUIPMENTS

MXL Strada	MXL Pista	MXL PRO/MXL PRO 05
<ul style="list-style-type: none"> • IR Lap Rx and Tx² • RPM sensor + cable • Channel Harnesses • Other sensors • External Expansion Modules³ 	<ul style="list-style-type: none"> • Split Transmitter • Other Sensors • External Expansion Modules³ 	<ul style="list-style-type: none"> • Split Transmitter • Channel Harnesses • Other Sensors • External expansion Modules³

¹ **Race Studio 2** is the software properly developed by **AIM** to configure the MXL and analyze stored data.

² IR Lap Rx and TX means “infrared Lap Receiver and Transmitter(s)”.

³ At present available External Expansion Modules are: TC Hub, Data Hub, LCU-ONE, DaVid, GPS, MemoryKey (except for **MXL Strada**)



2 – How to install and power MXL

To **install MXL** in your car or motorcycle:

- Install **MXL** vertically with the display perpendicular to vehicle direction of motion in order to correctly measure the lateral g-force using the internal accelerometer⁴.
- Choose a location where the display unit is not in contact with oil or fuel.
- Ensure that the system is not installed too close to heat sources.
- Protect **MXL** from vibration: use the included anti-vibration mountings;
- Avoid rigid connections between the display unit and the chassis: use anti-vibration mountings (Silent Blocks).

To **power MXL**:

- Connect **MXL** to an external **9-15 VDC** power source (the vehicle battery, for instance). Do not exceed these limits.
- Connect the red wire to the battery's positive pole (+) and the black one to the negative pole (-).
- **MXL** is powered by the vehicle master switch.

⁴ Standard feature on all MXL models except **MXL Strada** which does not support track mapping.

3 – How to sample the RPM

RPM signal may be sampled in two ways:

- from the ECU: on a square wave signal (from 8 to 50 V);
- from the coil: a high voltage RPM input (from 150 to 400 V).

4 – How to install and power receiver and transmitters

MXL works only with infrared beacon transmitters and receivers.

4.1 – Infrared receiver

The **Infrared receiver** needs to “see” the transmitter placed on the trackside. Install it with the **receiver eye** pointed toward the beacon transmitter. Ensure that the receiver has clear line of sight to the beacon transmitter on the correct side of the vehicle. The red circle below indicates the receiver eye.



4.2 – Infrared transmitters

AIM infrared transmitters are: the lap transmitter (traditional or new one) and the split transmitter, that emits a different signal and **MXL** can distinguish them.

4.2.1 – The lap transmitter

The Lap transmitter can be traditional or new type as shown in the figure below.

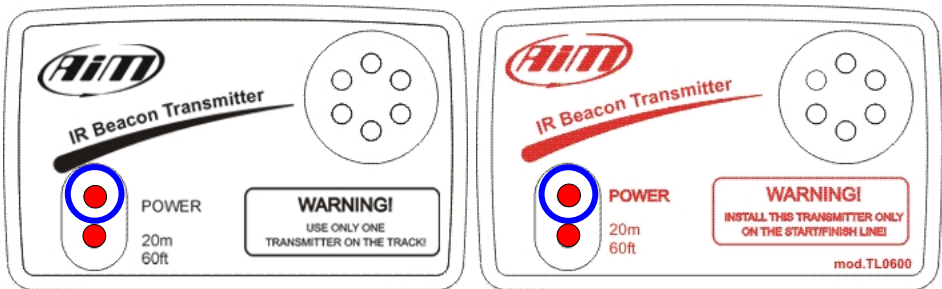

Traditional Lap transmitter

New Lap transmitter

The Lap transmitter can be **powered**:

- by 8 AA batteries (placed in the transmitter case) or
- by an external 12V power cable.

When battery charge status is low, the **power led** starts blinking each second.

The transmitter has two **operating modes**:

- Low power: track width less than 10 m (30 ft)
- High Power mode: track width more than 10 m (needs external 12V power).

To **activate High/Low Power** function

- Unscrew the transmitter case from the back
- Place the jumper clip circled in the figure below over one of the two connectors for low power mode or over both the connectors for high power.

Please note: when the transmitter is set to high power mode, **both power leds** light up when the transmitter is turned on. High power mode needs 12V external power.



When installing your transmitter on the track, please be sure to check for other transmitters which are not always placed at the start / finish line. The simplest approach is to use the same transmitter for all drivers/bikers during a race. Use **Obscuring Time** setting (see [how to set the system configuration](#) paragraph) to ensure that **MXL** reads only the transmitter you want. Incorrect Obscuring Time settings or unknown multiple transmitters can cause the **MXL** to record inaccurate or confusing lap times.

4.2.2 – The split transmitter

The Infrared Split transmitter emits a signal different from the one emitted by the Lap transmitter; **MXL** distinguishes the two signals and provides split timing.

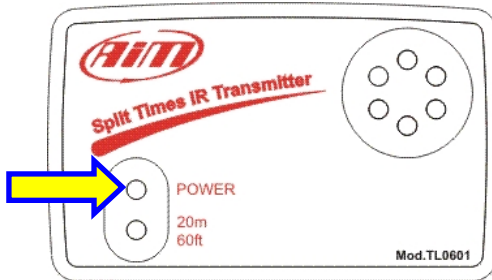

The infrared split transmitter

It works and is powered exactly like the lap transmitter. The only difference you can see is that power light (highlighted with an arrow above) is always blinking. When battery charge status is low, power led blinks more quickly.

Use the split transmitters in conjunction with the lap transmitter to mark various track sections for which you want separate times in addition to the overall lap times. This way you can compare your performance through a particular corner, for example, as you try different entry and exit strategies or different vehicle set ups. Using split times can help you find which sections of the track need the most work, allowing you to focus your efforts.



5 – How to connect MXL to the ECU

Your **MXL** can be interfaced with the engine computer (ECU) using an **RS232 serial cable** or a **CAN cable** to sample data out coming from the ECU.

To connect your **MXL** to the ECU, please use a **serial RS232** or a **CAN cable** and connect it to the connectors on the gauge backside.

If you have an ECU communicating through the **CAN** bus and you have our stock cable, they are already labelled; otherwise connect CAN +, CAN - and GND to your ECU pins. To know which pins support which cable, please refer to your ECU user manual.

If you have an ECU communicating through an **RS232 protocol**, the standard connection is:

- cable labelled **RS 232 RX** with the **ECU TX**
- cable labelled **GND** with **ECU GND**

PLEASE REFER TO YOUR ECU USER MANUAL TO BE SURE WHICH PINS ARE USED AND WHICH CABLE IS TO BE CONNECTED TO WHICH PIN.

To know if your ECU is supported by **MXL** and for more information about **MXL**-ECU connections, please refer always to our website: www.aim-sportline.com.

As ECU manufacturers continually update their products, refer to their website for the latest information, which may conflict with this manual.

6 – How to connect MXL to the GPS Module

Between the different external expansion modules you can connect your MXL through the CAN bus is also AIM GPS Lap timer. It allows you to record lap and split times without installing infrared receiver and transmitter on the track. The connection between MXL and GPS Lap timer is to be done as follows:

MXL Strada/MXL Pista: connect GPS Module to 5 pins 712 Binder connector on the back of **MXL** (pin 1 = CAN+; pin 4 = CAN-).

MXL Pro/MXL Pro05: connect GPS Module to 22 pins Deutsch connector on the back of **MXL** using the proper cable labelled as CAN Exp.

Please refer to MXL harness user manual for further information concerning **MXL** wiring and to GPS module user manual for further information concerning the installation of GPS Module on your vehicle. The figure below shows a CAN network made of **MXL** and GPS Module.

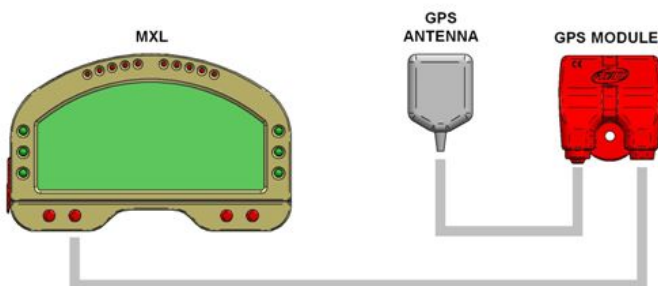

7 – How to read MXL display

MXL wide display shows a lot of information:

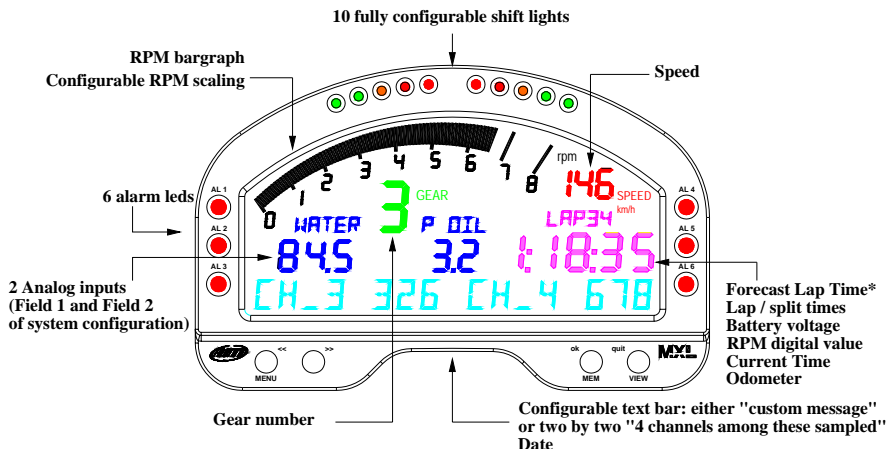

Description of **MXL** display

The displayed information are completely configurable via software (see [“How to configure MXL through Race Studio 2 software”](#)). The same display shows multiple pieces of information in the same place.

- ☀ Use **VIEW** button to switch between Forecast Lap Time⁵, Lap/split times, battery voltage, digital RPM value, current time and odometer (in the Figure **MXL** displays lap time – value 1:18:35).
- ☀ Use “>>” button to switch two by two between the four sampled channels shown on bottom row. If you enabled the static string (see [“how to set the system configuration”](#) paragraph) there is nothing you need to do.

⁵ **Forecast Lap Time** is an algorithm that predicts in real time the current lap time before it is completed. The dedicated paragraph explains this new **MXL** function.

7.1 – **MXL** alarm led and shift lights

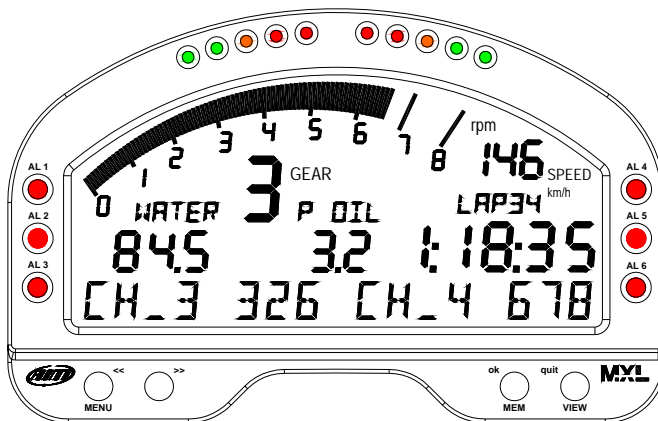

The **6 alarm leds** placed on the sides of the display unit can be linked to 6 different channels and, by setting the related channels threshold values, they can work as maximum or minimum alarms (see “[How to configure your MXL through Race Studio 2 software](#)”).

The **10 shift lights** on top of the **MXL** display unit are linked to engine RPM; values corresponding to each led can be set via software (see “[How to configure your MXL through Race Studio 2 software](#)”) or via keyboard (see “[Other keyboard functions](#)”).

7.2 – Forecast Lap time

Forecast Lap Time is an algorithm that predicts *in real time* the current lap time before it is completed. **MXL** compares each 0.1 km (0.16 miles) the current lap with a reference lap and, using this information, it predicts the final lap time value.

Forecast Lap Time is updated on the display as soon as a new value is computed. At present **Forecast Lap Time**:

- uses the best lap time as reference lap;
- is always functioning; there is nothing you need to do to activate it;
- only needs speed channel and lap sensor;
- is displayed where Lap Time is usually shown
- can be shown on the display while running pressing press “**VIEW**” button;
- produces two values shown in two pages of the display; the **First Page**, called “**FORE**” is the **Forecast Lap Time** that, using best lap time as reference, shows the complete lap time you are expected to do; the **second page**, called “**RTSPL**” is the **Real Time split** that, using the best lap time as reference, shows current gap between present lap and best lap time.

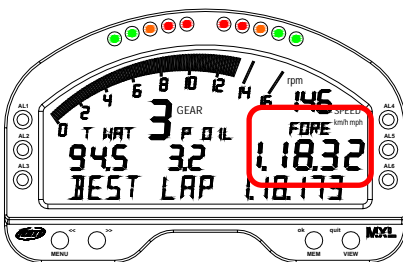

Forecast Lap Time – First Page “FORE”

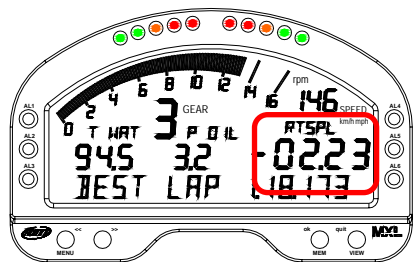

Forecast Lap Time – Second Page “RTSPL”



7.3 – Other useful information

The **MXL** automatically groups data for a track session as a **RUN**. A run is made up of the laps recorded between 2 pit stops / 2 power on-off / 2 samplings.

If the system is configured to capture **splits** (see [“how to set the system configuration”](#)) it shows “Split nr. X” up to the number of splits entered. Once times for each split have been recorded, the final segment is displayed as a completed lap.

When **MXL** records best lap time the text **“BEST LAP TIME”** appears in the bottom static string of your logger. This happens also if you have enabled the **static string** (see [“how to set the system configuration”](#)).

The logger has from eight (**MXL Strada, Pista, PRO**) to twelve (**MXL PRO 05**) analog channels, only six of which displayed. They are displayed as follows:

- on the left of the display are channels set on field 1 and 2 of System Configuration layer (see [“How to set the System Configuration”](#)) of **Race Studio 2** software.
- the static string area (if static string is not enabled) shows four other channels, two by two

The displayed channels setting is stored by the gauge and restored when it is switched on.



8 – How to install **Race Studio 2** and configure your **MXL**

MXL has been designed to connect with a PC through an USB cable and **can only be configured through Race Studio 2 software**.

In the **MXL** package you'll find the USB cable and software CD-ROM. **MXL** configuration is possible **ONLY** after software and USB driver installation on your PC.

PLEASE NOTE: the installation process described below is subject to change, please check our website for the most up to date information before proceeding. Further, please check our website for the most up to date Race Studio 2 version and **MXL** firmware release.

For further information concerning Race Studio 2 and USB drivers installation and troubleshooting, you can always refer to Race Studio 2 installation manual, “Installation_xxx.pfd” file, on the same website.



8.1 – How to install **Race Studio 2** and the USB driver

The **Race Studio 2** software has been designed to guarantee maximum working reliability and **proper compatibility has been tested with the following operating systems:**

- **Windows XP™.**
- **Windows Vista**

To install **Race Studio 2** software and the USB driver on your PC, please follow the appropriate directions as detailed below.



8.1.1 - Race studio 2 installation for Windows XP

- **Check** windows “**Drivers signing option**” default setting: click “Start / Settings/Control Panel/System → select “Hardware” layer → click on “Driver Signing” option and ensure that “Warn – Prompt me each time to choose an action” checkbox is enabled → “OK” → “OK”; close all windows.
- **Close all applications** and if **MXL** is connected to the Pc **unplug** it.
- Insert **Race Studio 2** CD in the CD Rom drive and installation starts automatically; if not browse the CD and click on Setup icon.
- Press “Next” button
- Press “Finish” button
- Press “Start” button
- Press “Start” button
- Press “Continue anyway” button
- Press “Continue” button
- Connect **MXL** to your Pc and switch it on
- After a few seconds “Find New Hardware” message appears bottom right on your Pc Desktop. A window appears: click on “No, not now” button
- Enable “Install the software automatically” checkbox → press “Next” button.
- Press “Finish” button
- Press “OK” button
- Press “Finish” button

8.1.2 - Windows XP trouble shootings

If USB driver installation did not succeed, please click on:

Start\Program files\AIM\AIM_USB_DRIVER_2008\AIM_USB_Inst_2008.exe

- Press “Reinstall driver” button

8.1.3 - Race studio 2 installation for Windows Vista

Microsoft Vista™ operating system has introduced a more restricted procedure regarding the security.

Note: AIM has not yet obtained the “signature” from Microsoft. The procedure is in progress and, once completed, will make the installation completely automatic.

The installation program for “non-signed” drivers requires the program to be started with the “Run as Administrator” procedure. This means that to operate this correctly you must start **Microsoft Vista**™ using an “Administrator” account. Stand alone PC are normally sold with this type of account. This is explained in greater detail below.

AIM software installation will create an icon on your desktop to allow you starting the USB driver installation with the special “Run as Administrator” procedure.



AIM_USB_2008

Before starting software installation, please ensure that your instrument is **NOT** connected to the PC USB port. If it is, please unplug it.

- Insert AIM software installation CD in your CD/DVD drive: the installation starts automatically; otherwise browse the Cd and double click on “SETUP” icon.
- Click on “Next” button
- Click on “Finish” button
- Click on “OK” button
- Click on “OK” button
- Click on “Finish” button

The icon showed before is now on your Pc desktop. Right click on it.



- Select “Run as administrator” option
- Click on “Yes” button.
- Click on “Start” button
- Click on “Start” button
- Click on “OK” button
- Click on “Install this driver software anyway” button
- Click on “Continue” button
- Connect your **MXL** to the Pc

8.1.4 – Windows Vista trouble shootings

If the procedure ended incorrectly for any reason, you can start the “Maintenance” Procedure repeating the “Run as Administrator” procedure.

- Go on your Pc Desktop
- Right click on “AIM_USB_2008” icon
- Click on “Reinstall Driver” button
- Click on “Yes” button.

8.2 – How to configure **MXL** through **Race Studio 2** software

To configure **MXL** through **Race Studio 2** software:

- Run **Race Studio 2** software
- Click on **MXL** button on the left vertical toolbar

8.2.1 – Creating and managing **MXL** configurations

If you are configuring **MXL** for the first time, New Configuration window appears:

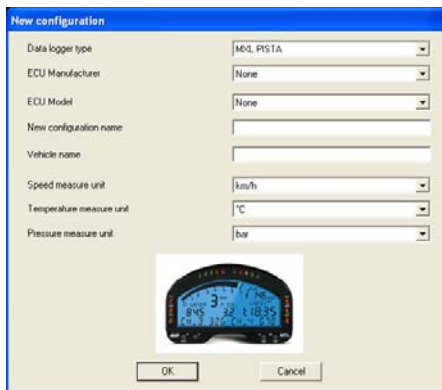

- Choose your logger from: **MXL Strada, Pista, PRO, PRO 05**;
- Choose the Manufacturer of your ECU if supported (see “[How to connect MXL to the ECU](#)” chapter).
- Choose your ECU Model;
- Enter a name for your new configuration;
- Enter your Vehicle name;
- Choose Speed, Temperature and Pressure measure unit;
- Press “OK” button

System Manager window appears. This window allows you to manage all commands related to **MXL** configuration.

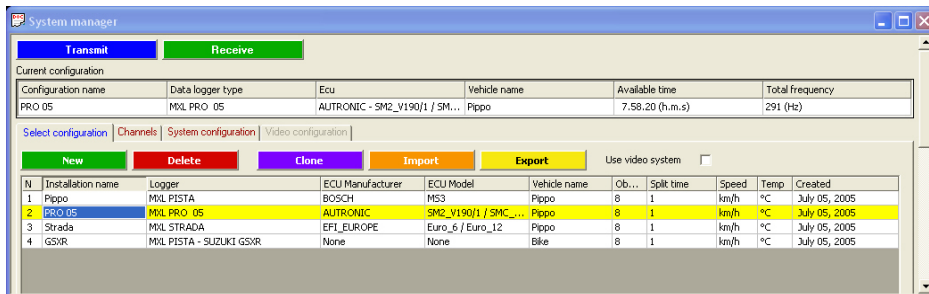

On top of this window are two pushbuttons that allows you to:

Transmit

Transmit a configuration to the Logger.

Receive

Detect an unknown configuration and store it in the configurations database.

Immediately under is a row, always displayed, showing all information related to the configuration you are working on (Current configuration window):

The remaining part of the window is made up of four layers:

- Select Configuration
- Channels
- System Configuration
- Video Configuration. This last layer enables only if you checked "Use Video System" checkbox on Select configuration layer and is needed only for **DaVid** Slave Expansion version owners (see related User Manual for more information).

8.2.2 – How to set and select a configuration

→ Activate “**Select Configuration**” layer

N	Installation name	Logger	ECU Manufacturer	ECU Model	Vehicle name	O...	Split time	Speed	Te...	Created
1	Pippo	MXL PISTA	BOSCH	MS3	Pippo	8	1	km/h	°C	July 05, 2005
2	PRO 05	MXL PRO 05	AUTRONIC	SM2_V190/1 / SM...	Pippo	8	1	km/h	°C	July 05, 2005
3	Strada	MXL STRADA	EFT_EUROPE	Euro_6 / Euro_12	Pippo	8	1	km/h	°C	July 05, 2005
4	G5XR	MXL PISTA - SUZUKI G5XR	None	None	Bike	8	1	km/h	°C	July 05, 2005

- press “**New**” button to create a new configuration
- press “**Delete**” button to delete an existing configuration
- press “**Clone**” button to Clone/Copy an existing configuration
- press “**Import**” button to import a configuration in your database
- press “**Export**” button to export a configuration from this database and be able to use it elsewhere
- Enable “**Use video System**” Checkbox if you are using the **DaVid** Slave Expansion version (see related User Manual for further information);
- Select a configuration to set (it becomes highlighted in yellow).

8.2.3 – How to set MXL Channels

→ Activate “Channels” layers

Select configuration: **Channels** | System configuration | Video configuration

Speed_1

Enabled

Wheel circumference (mm)

Pulses per wheel revolution

Speed_2

Disabled

Wheel circumference (mm)

Pulses per wheel revolution

Speed_3

Disabled

Wheel circumference (mm)

Pulses per wheel revolution

Speed_4

Disabled

Wheel circumference (mm)

Pulses per wheel revolution

Channel identifier	Enabled/disabled	Channel name	Sampling ...	Sensor type	Measur...	Lower bound	Upper bound	Param. 1
RPM	Disabled	Engine	10 Hz	Engine revolution speed	rpm	0	20000	1.800
SPD_1	Enabled	Speed_1	10 Hz	Speed	km/h .1 0.0	250.0	1666.0	
SPD_2	Disabled	Speed_2	10 Hz	Speed	km/h .1 0.0	250.0	1666.0	
SPD_3	Disabled	Speed_3	10 Hz	Speed	km/h .1 0.0	250.0	1666.0	
SPD_4	Disabled	Speed_4	10 Hz	Speed	km/h .1 0.0	250.0	1666.0	
CH_1	Enabled	Channel_1	10 Hz	Generic linear 0-5 V	V .1 0.0	0.0	5.0	
CH_2	Enabled	Channel_2	10 Hz	Generic linear 0-5 V	V .1 0.0	0.0	5.0	
CH_3	Enabled	Channel_3	10 Hz	Generic linear 0-5 V	V .1 0.0	0.0	5.0	
CH_4	Enabled	Channel_4	10 Hz	Generic linear 0-5 V	V .1 0.0	0.0	5.0	
CH_5	Enabled	Channel_5	10 Hz	Generic linear 0-5 V	V .1 0.0	0.0	5.0	
CH_6	Enabled	Channel_6	10 Hz	Generic linear 0-5 V	V .1 0.0	0.0	5.0	
CH_7	Enabled	Channel_7	10 Hz	Generic linear 0-5 V	V .1 0.0	0.0	5.0	
CH_8	Enabled	Channel_8	10 Hz	Generic linear 0-5 V	V .1 0.0	0.0	5.0	
CH_9	Enabled	Channel_9	10 Hz	Generic linear 0-5 V	V .1 0.0	0.0	5.0	
CH_10	Enabled	Channel_10	10 Hz	Generic linear 0-5 V	V .1 0.0	0.0	5.0	
CH_11	Enabled	Channel_11	10 Hz	Generic linear 0-5 V	V .1 0.0	0.0	5.0	
CH_12	Enabled	Channel_12	10 Hz	Generic linear 0-5 V	V .1 0.0	0.0	5.0	
CALC_GEAR	Enabled	Calculated_Gear	10 Hz	Calculated Gear	#	0	9	
ACC_1	Enabled	Acc_1	10 Hz	Lateral accelerometer	g .01	-3.00	3.00	
LOG_TMP	Enabled	Datalogger_Temp	10 Hz	Cold joint	°C	0	50	
BATT	Enabled	Battery	1 Hz	Battery	V .1	5.0	15.0	
ECU_1	Enabled	AUTR_RPM	10 Hz	Engine speed sensor	rpm	0	20000	
ECU_2	Enabled	AUTR_SPEED	10 Hz	Speed sensor	km/h .1	0.0	350.0	
ECU_3	Enabled	AUTR_DRIVWHEEL_SPD	10 Hz	Speed sensor	km/h .1	0.0	350.0	
ECU_4	Enabled	AUTR_WATER_TEMP	10 Hz	Temperature sensor	°C	-10	150	
ECU_5	Enabled	AUTR_CHARGE_TEMP	10 Hz	Temperature sensor	°C	0	70	
ECU_6	Enabled	AUTR_INTAKEAIR_TEMP	10 Hz	Temperature sensor	°C	0	70	
ECU_7	Enabled	AUTR_EXHAUST_PRESS	10 Hz	Pressure sensor	kPa .1	0.0	150.0	
ECU_8	Enabled	AUTR_MANIF_PRESS	10 Hz	Pressure sensor	kPa .1	0.0	150.0	
ECU_9	Enabled	AUTR_THROTTPOS	10 Hz	Percentage sensor	% .1	0.0	100.0	
ECU_10	Enabled	AUTR_INJECT_TIME	10 Hz	System clock	us	0	5000	
ECU_11	Enabled	AUTR_IGNIT_ANG	10 Hz	Angle sensor	deg	0	90	
ECU_12	Enabled	AUTR_AF_RATIO	10 Hz	Lambda sond	A/F .01	0.00	100.00	
ECU_13	Enabled	AUTR_BATT_VOLT	10 Hz	Voltmeter	V .1	0.0	15.0	

Channels Layer layout depends on your **MXL** version. It allows you to set the channels acquired by your **MXL** and you have to:

- set as many speed boxes (related to the vehicle wheels) as your logger has. This means: **4 Speed** boxes for **MXL PRO/PRO 05** and **one speed** box for **MXL Strada/MXL Pista**
- Set channels table

Speed boxes:

Speed_1

Wheel circumference (mm)

Pulses per wheel revolution

Speed_2

Wheel circumference (mm)

Pulses per wheel revolution

You can decide whether to use each of those channels or not.

To use it:

- Press Enabled button
- Type in the related wheel circumference
- Enter the number of pulses for wheel revolution (the number of magnets you have installed on the wheel)
- The related row in “Channels table” becomes enabled

Not to use it:

- Press Disabled button
- The related row in “channels table” becomes disabled.



Channel Table:

Channel identifier	Enabled/disabled	Channel name	Sampling ...	Sensor type	Measur...	Lower bound	Upper bound	Param. 1
RPM	Disabled	Engine	10 Hz	Engine revolution speed	rpm	0	20000	1.000
SFD_1	Enabled	Speed_1	10 Hz	Speed	km/h .1	0.0	250.0	1666.0
SFD_2	Disabled	Speed_2	10 Hz	Speed	km/h .1	0.0	250.0	1666.0
SFD_3	Enabled	Speed_3	10 Hz	Speed	km/h .1	0.0	250.0	1666.0
SFD_4	Enabled	Speed_4	10 Hz	Speed	km/h .1	0.0	250.0	1666.0
CH_1	Enabled	Channel_1	10 Hz	Generic linear 0-5 V	V .1	0.0	5.0	
CH_2	Disabled	Channel_2	10 Hz	Generic linear 0-5 V	V .1	0.0	5.0	
CH_3	Disabled	Channel_3	10 Hz	Generic linear 0-5 V	V .1	0.0	5.0	
CH_4	Enabled	Channel_4	10 Hz	Generic linear 0-5 V	V .1	0.0	5.0	
CH_5	Enabled	Channel_5	10 Hz	Generic linear 0-5 V	V .1	0.0	5.0	
CH_6	Enabled	Channel_6	10 Hz	Generic linear 0-5 V	V .1	0.0	5.0	
CH_7	Enabled	Channel_7	10 Hz	Generic linear 0-5 V	V .1	0.0	5.0	
CH_8	Enabled	Channel_8	10 Hz	Generic linear 0-5 V	V .1	0.0	5.0	
CALC_GEAR	Enabled	Calculated_Gear	10 Hz	Calculated Gear	#	0	9	
ACC_1	Enabled	Acc_1	10 Hz	Lateral accelerometer	g .01	-3.00	3.00	
LOG_TMP	Enabled	Datalogger_Temp	10 Hz	Cold joint	°C	0	50	
BATT	Enabled	Battery	1 Hz	Battery	V .1	5.0	15.0	
ECU_1	Enabled	MEFI-4B_RPM	10 Hz	Engine speed sensor	rpm	0	20000	
ECU_2	Enabled	MEFI-4B_ECT	10 Hz	Temperature sensor	°C	0	20000	
ECU_3	Enabled	MEFI-4B_ETV	10 Hz	Voltmeter	V .1	0.0	255.0	
ECU_4	Enabled	MEFI-4B_EOP	10 Hz	Pressure sensor	kPa	30	150	
ECU_5	Enabled	MEFI-4B_SPEED	10 Hz	Speed sensor	km/h .1	-30.0	150.0	
ECU_6	Enabled	MEFI-4B_FUELCONS	10 Hz	Consumption Sensor	gal/h .1	0.0	100.0	
ECU_7	Enabled	MEFI-4B_STATUS	10 Hz	Raw value	#	0	100	
ECU_8	Enabled	MEFI-4B_FUELPRESS	10 Hz	Pressure sensor	kPa	0	15	
ECU_9	Enabled	MEFI-4B_EGRFB	10 Hz	Voltmeter	V .1	0.0	15.0	
ECU_10	Enabled	MEFI-4B_FTEMP	10 Hz	Temperature sensor	°C	0	1000	
ECU_11	Enabled	MEFI-4B_MAT	10 Hz	Temperature sensor	°C	0	255	
ECU_12	Enabled	MEFI-4B_RUNTIME_HOUR	10 Hz	Raw value	#	0	350	
ECU_13	Enabled	MEFI-4B_RUNTIME_MIN	10 Hz	Raw value	#	0	350	
ECU_14	Enabled	MEFI-4B_RPM2	10 Hz	Raw value	#	0	350	
ECU_15	Enabled	MEFI-4B_MAP_VOLTS	10 Hz	Voltmeter	V .1	0.0	350.0	
ECU_16	Enabled	MEFI-4B_MAP	10 Hz	Pressure sensor	kPa	0	350	

Channel Identifier column: identifies each channel (RPM, Speed, Configurable channels, labelled as CH_X, ECU channels if a supported ECU is connected).

Enabled/Disabled column: shows channels status (enabled/disabled) and allows you to enable/disable them with a double click on the cell (except for RPM, Speed and gear channels that have to be set through “System Configuration” layer).

Channel name column shows each channel name and allows you to change it double clicking on the cell and inserting the desired channel name.

Sampling column shows each channel sampling frequency and allows you to change it double clicking on the cell⁶.

⁶ **Please note:** increasing sampling frequency decrease maximum storage time as more samples are created, filling the memory faster (see “My MXL memory” paragraph).

Sensor Type column: shows the type of sensor you have installed on each channel and allows you to set a sensor on a configurable channel choosing it from the list of pre-defined sensors. You can also set a custom sensor but you need to create it before (see “[Custom sensors](#)”).

Measure Unit column: shows the selected unit of measure for each configured channel and allows you to change it with a double click.

Lower and **Upper bound** columns show sensor lower and upper bounds and allows you to change them with a double click on the cell.

Param. 1 column shows you the first parameter set for each channel. How to change this value depends on the channel it refers to. For Speed, RPM and gear channels you need to set the parameter in the related boxes, for some sensors, like a distance potentiometer for instance, you can double click on this cell and a panel concerning the channel appears on bottom left corner of the screen. In the figure below is a panel referring to a distance potentiometer.

Channel Name	Sensor type	Measure unit
Channel_9	Potentiometer distance	mm .1

Parameters

1	Maximum potentiometer used travel	<input type="text" value="100"/>
---	-----------------------------------	----------------------------------

For **single channels configuration**, the characteristics of each channel are explained below:

- Channels labelled from **CH_1 to CH_7** for **MXL Strada/Pista/PRO** and channels labelled from **CH_1 to CH_11** for **MXL PRO 05** are user defined. You may choose the sensor to install among a long list of **AIM** standard sensors. For each configurable channel you can also set channel name and sampling frequency.



- Channel labelled **CH_8** (on **MXL Strada**, **PISTA** and **PRO**) and **CH_12** (on **MXL PRO 05**) setting depends on how you set “Gear sensor” box in “System Configuration” Layer (see [“How to set the system configuration”](#)).
 - If you set “**Potentiometer Channel 8/12**” or “**Calculated with neutral signal: Channel 8/12**”, the channel labelled as CH_8/12 switches to Calculated Gear and you can only set Channel Name and sampling frequency.
 - if you set “**Calculated**”, “**ECU**” or “**None**” channel labelled as CH_8/12 becomes an user defined channel and works exactly like all the other channels.
- If you have an **MXL Pista**, **PRO** or **PRO 05** you may also choose a channel for an optional external gyroscope (bike installations), which allows you to create a track map. This sensor can only be installed:
 - on channels 4, 5, 6, 7 and 8 for **MXL Strada** and **MXL Pista**
 - on any channel for **MXL PRO**
 - on channels 8, 9, 10 and 11 for **MXL PRO 05**.
- If you have an **MXL Pista**, **MXL PRO** or an **MXL PRO 05** (Car installations) the gauge comes standard with an internal lateral accelerometer, labelled as ACC_1, which allows you to create the track map.

8.2.4 – How to set the System Configuration

→ Activate System Configuration Layer

- Set **RPM** box
- Set **Gear Sensor** Box
- Set **Channel for alarm** boxes and **Measure** Fields
- Set **Enable Static string** box if you wish to use it
- Set **Lap** box
- Set **Speed** box
- Set **Shift Lights** boxes

Here follow instructions on how to set each of these.

Rpm box

Rpm

AIM sensor Multiply Factor / 1

ECU signal MAX value 16000

Led None Threshold 0

Rpm

ECU signal Multiply Factor / 1

MAX value 16000

Led None Threshold 0

- enable “**AIM Sensor**” and set Multiply Factor and RPM Max Value if you have installed an RPM sensor on your vehicle and connected it to your gauge. The RPM row in the channel table is now enabled.
- enable “**ECU Signal**” and set RPM MAX value if you are sampling this channel directly from the ECU of your vehicle

You can also link RPM Max value to one of the six alarm leds to trigger it when the engine reaches the specified RPM value. In the example below, RPM threshold is 15,000 and linked to Led 2. The led does not switch off until data download is made. In this specific situation the channel for alarm corresponding to led 2 is disabled, as the RPM Max Value overrides it. We suggest you set threshold value corresponding to ECU's RPM limiter⁷.

Rpm

ECU signal Multiply Factor / 1

MAX value 16000

Led 2 Threshold 15000

Gear sensor Box

MXL can detect the engaged gear using an on-board gear sensor, sampling it from the ECU, or calculating it using an algorithm based on engine **RPM** and **Speed**. Available options are:

- None,
- Potentiometer Channel 8 (Channel 12 for **MXL PRO 05**)
- ECU
- Calculated
- Calculated with neutral signal Channel 8/12

⁷ This setting is very useful to quickly highlight an over-rev situation due to poor downshifting without opening **Race Studio Analysis** software.

Gear sensor

None	Calculated
Potentiometer Channel 8	Calculated with neutral signal: Channel 8
ECU	Highest gear number 6

→ Select **“None”** if no sensor is installed or you do not wish to see the gear number: this option will be disabled on your display.

Gear sensor

None	Calculated
Potentiometer Channel 8	Calculated with neutral signal: Channel 8
ECU	Highest gear number 6

→ Select **“Potentiometer Channel 8/12”** if your vehicle is equipped with a gear potentiometer installed on channel 8/12. Ch_8/12 of Channel table sets to Calculated Gear.

Gear sensor

None	Calculated
Potentiometer Channel 8	Calculated with neutral signal: Channel 8
ECU	Highest gear number 6

→ Select **“ECU”** if you wish to see this information coming from your vehicle’s ECU (assuming it can transmit it).

Gear sensor

None	Calculated
Potentiometer Channel 8	Calculated with neutral signal: Channel 8
ECU	Highest gear number 6

→ Select **“Calculated”** to calculate the engaged gear through an algorithm based on RPM and speed; fill in “Highest gear number” box.

Gear sensor

None	Calculated
Potentiometer Channel 8	Calculated with neutral signal: Channel 8
ECU	Highest gear number 6

→ Select **“Calculated with neutral signal: Channel 8/12”** if you have a neutral sensor you can use to both calculate gears and see neutral gear. Fill in “Highest Gear Number” box.

Channel for alarm and measure boxes

HIGH LOW	Channel for alarm	Threshold
H	Channel_1	90
L	Channel_3	2.5
H	Channel_5	0

Link alarm to measure fields

Measure	Short name
Field 1 - always displayed	
Channel_1	CH_1
Field 3 - page 1	
Channel_3	CH_3
Field 3 - page 2	
Channel_5	CH_5

HIGH LOW	Channel for alarm	Threshold
H	Channel_1	90
L	Channel_3	2.5
H	Channel_5	0

Link alarm to measure fields

Measure	Short name
Field 1 - always displayed	
Channel_1	CH_1
Field 3 - page 1	
Channel_3	CH_3
Field 3 - page 2	
Channel_5	CH_5

Channel boxes are connected to the 6 alarm leds of your **MXL** display.

- set each channel as *Max.* (“H” high) or *Min.* (“L” low) alarm.
- Insert Threshold value.

Note: if Led option in RPM box (see RPM box) is enabled, the led of the channel linked to RPM max value partially disables: you can only set its threshold value.

Field boxes are linked to the field shown on **MXL** display (see “[How to read MXL display](#)”). The first on the left and on the right are always displayed. The other four field boxes can be shown two by two on the bottom string of the display with the name written in the column “Short name”.

- Select the channel you want to display
- insert its short name

Link alarm to measure field option (enabled in the figure on the right above):

- allows you to link the 6 alarm leds to the 6 channels you can display;
- the channel for alarm boxes disables and you can only set HIGH / LOW thresholds.
- If you enabled “Led” option in **RPM box** this channel is completely disabled.

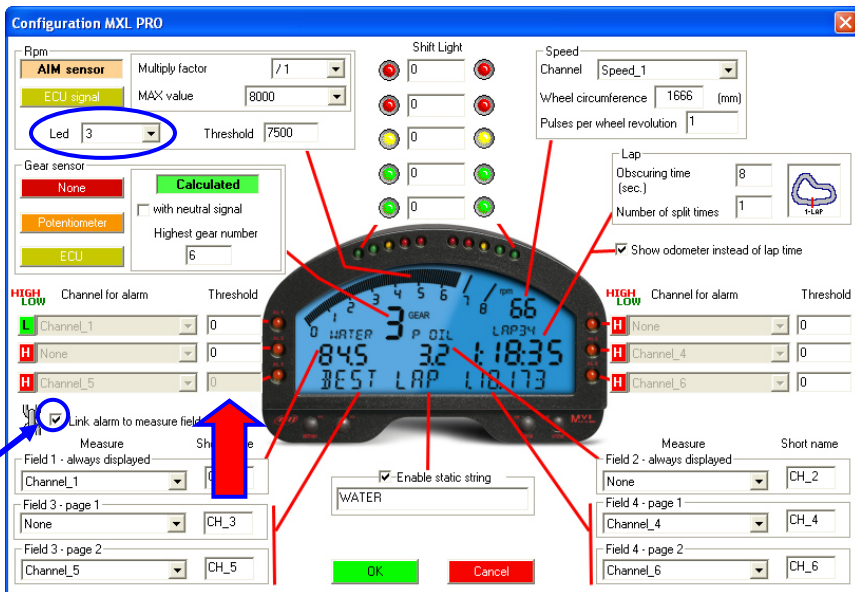

Alarms are linked to measure fields and led option in RPM box is enabled

Enable static string box

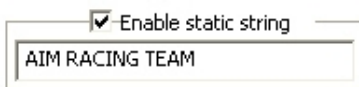

To enable the static string:

- place a check in the related checkbox
- insert the message you want to display

When static string is disabled the correspondent part of the display shows (two by two) fields 3 and 4 related to page 1 and 2 of the display.

Note: if you set “Gear Calculated” in Gear sensor box, **MXL** has to compute gears (see “[How to make gear calculation proceeding](#)”). During gear calculation the static string is excluded; the display shows “Running Gear Cal” text.

Lap box

Lap		
Obscuring time (sec.)	<input type="text" value="5"/>	
Lap segments	<input type="text" value="3"/>	

Lap		
Obscuring time (sec.)	<input type="text" value="5"/>	
Lap segments	<input type="text" value="3"/>	

- Show odometer instead of lap time Show odometer instead of lap time
- > Insert the obscuring time (accepted value from 3 to 255 seconds)
 - > Insert the number of segment (accepted values from 1 to 6)
 - > Enable “Show odometer instead of lap time” if you want to see it.

What is Obscuring time: “Obscuring time” is a time period during which the optic receiver, after having detected a beacon, is “blind” and will ignore other beacons. This needs to be set correctly if more than one beacon is used at the track.

If you do not wish to capture split times on a track where more than one transmitter is positioned, you need to set the obscuring time to a value lower than the track best lap time and higher than the time elapsed between last split and Start/Finish line. If you wish to capture split times you need to set these parameters to a low value.

What are Lap segments: “Lap segments” is the number of segments you wish to divide your track in and should coincide with the number of transmitters installed on the track.

Notes:

1. Lap segments configuration is ignored when the track you are running on is equipped with the new lap/split transmitters
2. If you enable **odometer** box the system configuration re-switches automatically to **Lap time** when a lap time is captured.
3. The logger stores configuration settings so switching it off and then switching it on again configuration settings will be restored.

Speed box

Speed
Channel ▾
Wheel circumference (mm)
Pulses per wheel revolution

Speed
Channel ▾
Wheel circumference (mm)
Pulses per wheel revolution

- Choose the speed you want to display
- Set Wheel circumference and Pulses per wheel revolution (except if you choose a speed sampled from the ECU like in the figure on the right).

Shift light box (this function is also settable via keyboard)

Shift Light

	<input type="text" value="11000"/>	
	<input type="text" value="10800"/>	
	<input type="text" value="10500"/>	
	<input type="text" value="9800"/>	
	<input type="text" value="9500"/>	

- Manages the 10 leds placed on top of **MXL**.
- They turn progressively on; when the engine reaches the RPM value set in the 1st box all leds start blinking, warning you to change gear.
- If a value is set to 0 the corresponding led is disabled.

8.3 – How to transmit the configuration

Once you have the configuration set in the software, you need to transmit it to your **MXL** via the USB connection in order for it to take effect:

- Leave your Pc switched on with **Race Studio 2** running
- Connect USB cable to the PC USB port and to the port on the left side of **MXL**
- Switch **MXL** on
- Go to **Race Studio 2** System Manager main window
- Press “**Transmit**” button on **Race Studio 2** top toolbar.

- This window appears and led AL2 on the left of **MXL** switches on for a few seconds.

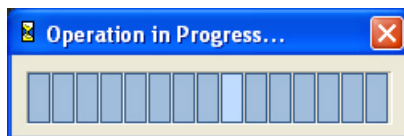

- This window appears and led AL2 on the left of **MXL** has switched off.

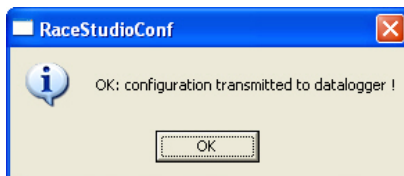

8.3.1 –Configuration transmission troubleshooting

During Configuration transmission you may see various error messages:

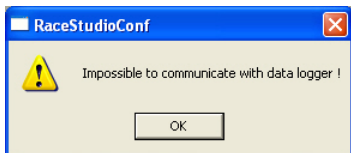

- Check if USB cable is correctly plugged into the PC and into the logger USB port;
- re-try to transmit the configuration.

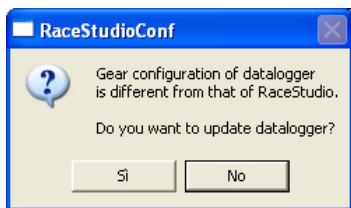

- The configuration you are trying to transmit to the logger has a different gear setting (see **Gear Box** paragraph).
- Press "OK" button if you want to change gear box settings.

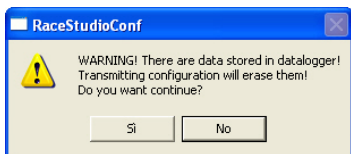

- The system warns you that the logger you are trying to transmit the configuration to has data stored in its memory they will be deleted if you transmit the configuration.

Note 1: “Race Studio 2” Visualization problems

If when you run **Race studio 2** you monitor shows you a distorted image, like the one reported below, you need to change your screen settings. In the example below we pressed “**MXL**” button.

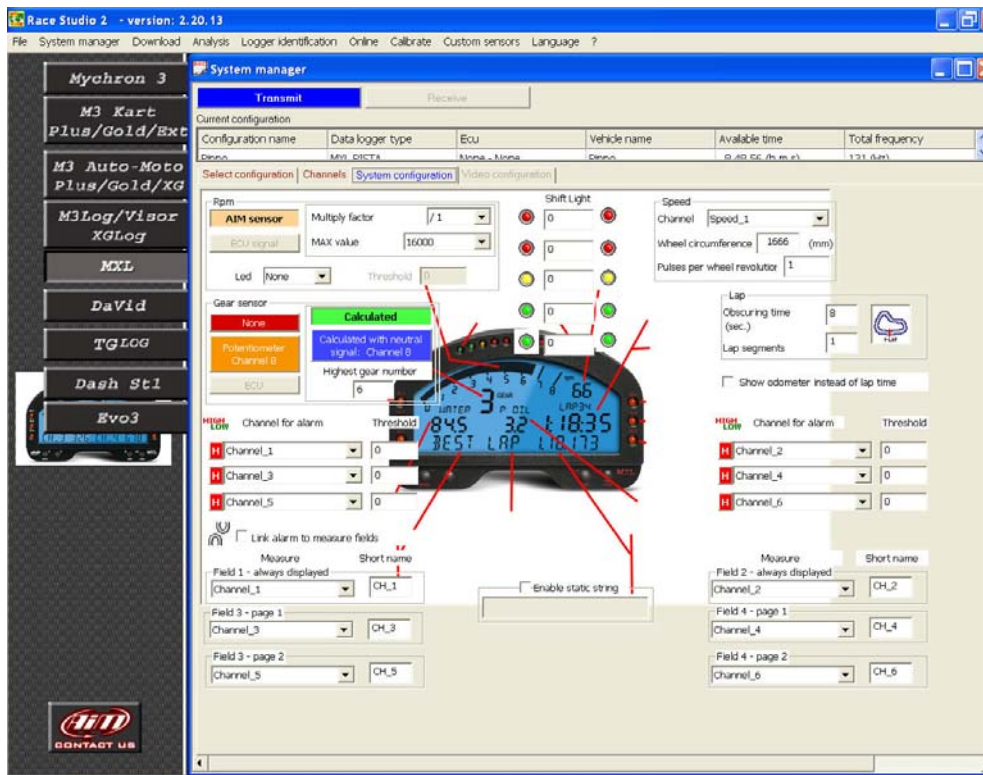

First of all, close all running applications (**Race Studio 2** included) as this operation need Pc rebooting.

To change your screen settings:

- > Click on “Start/Settings/Control Panel/Display
- > Display Properties windows appears

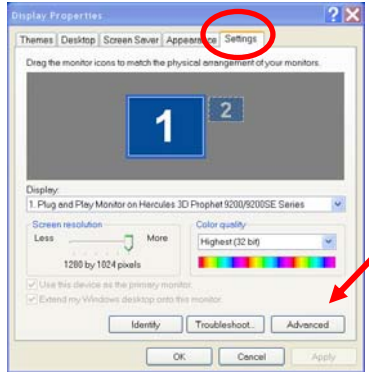

- > Enable Settings layer
- > Press Advanced button

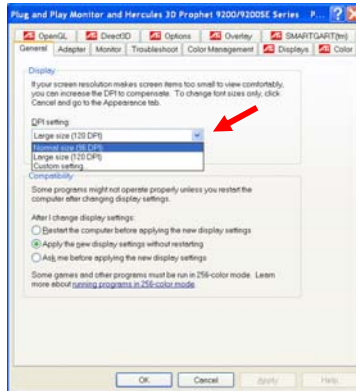

- > Set DPI setting on “**Normal Size (96 DPI)**”

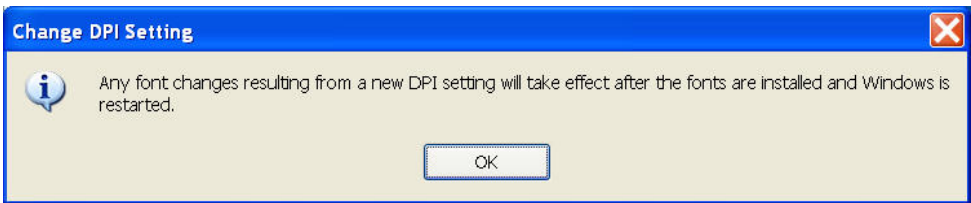

- Click on “OK” button

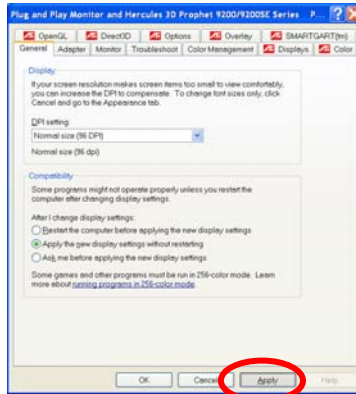

- Click on “Apply” button

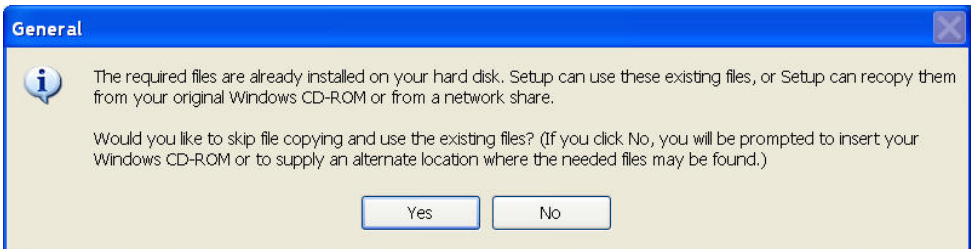

- If this message appears, click on “Yes” button

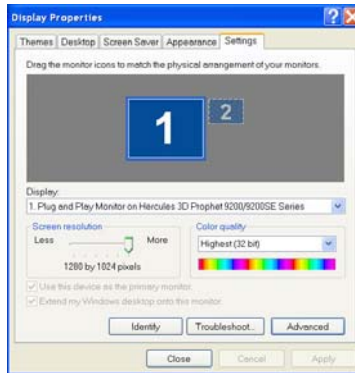

- Click on “Close” button

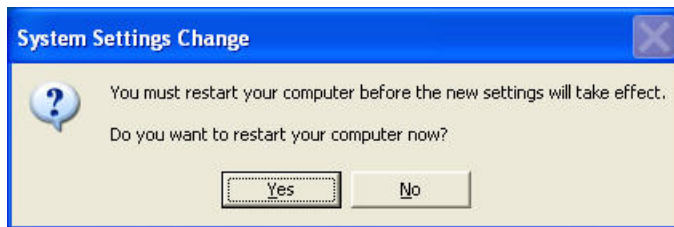

- Click on “Yes” button and re-start your computer.
- After re-start run “**Race Studio 2**” and all should work properly.

9 – Sensors Management

MXL can manage both on board and custom sensors. Some sensors, like potentiometers and accelerometers, need to be calibrated / auto-calibrated.

9.1 – Custom sensor (expert users only)

Pressing “Custom sensors” button in the top toolbar. This window appears:

The screenshot shows the 'Customize sensor' window. It features a table with columns for 'x [mV]', 'y', and 'Curve Error'. A green 'Compute Curve' button is located above the graph. The graph displays a parabolic curve with data points. The control panel on the right includes a 'Select sensor' dropdown (set to 'Parabolic sensor'), 'Sensor name' and 'Sensor unit' input fields (set to 'Parabolic sensor' and 'mV' respectively), 'Sensor type' radio buttons (set to 'Temperature'), and buttons for 'Save sensor', 'Delete sensor', 'Import sensors', 'Export selected sensor', 'Export all sensor', and 'Exit'.

	x [mV]	y	Curve Error	
<input checked="" type="checkbox"/>	1	0	0	-0.000
<input checked="" type="checkbox"/>	2	2	400	0.000
<input checked="" type="checkbox"/>	3	4	1600	0.000
<input checked="" type="checkbox"/>	4	6	3600	0.000
<input checked="" type="checkbox"/>	5	1	100	0.000
<input checked="" type="checkbox"/>	6	3	900	0.000
<input checked="" type="checkbox"/>	7	7	4900	0.000
<input type="checkbox"/>	8	0	0	0.0
<input type="checkbox"/>	9	0	0	0.0
<input type="checkbox"/>	10	0	0	0.0
<input type="checkbox"/>	11	0	0	0.0
<input type="checkbox"/>	12	0	0	0.0
<input type="checkbox"/>	13	0	0	0.0
<input type="checkbox"/>	14	0	0	0.0
<input type="checkbox"/>	15	0	0	0.0
<input type="checkbox"/>	16	0	0	0.0
<input type="checkbox"/>	17	0	0	0.0
<input type="checkbox"/>	18	0	0	0.0
<input type="checkbox"/>	19	0	0	0.0
<input type="checkbox"/>	20	0	0	0.0

Graph equation: $y = a_0 + a_1 * x + a_2 * x^2 + a_3 * x^3 + a_4 * x^4$

Coefficients:
 $a_0 = -1.522501e-011$
 $a_1 = 8.094815e-011$
 $a_2 = 100.000000$
 $a_3 = 1.213412e-011$
 $a_4 = -8.376035e-013$

Through it you can:

- create a new custom sensor,
- modify an existing sensor
- import/export a sensor or all sensors using the related button
- delete a sensor using the related button

9.1.1 – How to create a custom sensor

- Press “**Custom Sensors**” on the top toolbar
- **Enable the checkboxes** on the left corresponding to the number of experimental values you want to use (up to 20 experimental values).
- **Insert the values** corresponding to the sensor you want to create in the three columns on the left of the window considering that:
 - first column: is logger output voltage in mV (abscissa of the calibration curve);
 - second column: are temperature / pressure values corresponding to the voltage output (these values are interpolated using a polynomial)
 - third column: Curve Error, that is useful to verify that the curve calculated by the software is faithful to the experimental values.
- click on “**Compute Curve**” button
- fill in “**Sensor name**” box
- fill in “**Sensor Unit**” of Measure box
- select “**Sensor type**”: Temperature, Pressure or Other Type
- click on “**Save**” Button
- click on “**Exit**” button
- set the new sensor on the desired channel (see “[How to set MXL channels](#)”).

9.1.2 – How to modify a custom sensor

- press “**Custom Sensors**” on the top toolbar
- select the sensor you want to modify choosing it in “**Select Sensor**” box
- modify the sensor related values
- click on “**Compute Curve**” button
- fill in “**Sensor name**” box
- click on “**Save**” button

9.2 – How to calibrate / auto-calibrate a sensor

Once the configuration has been transmitted to **MXL**, it is absolutely necessary to calibrate / auto calibrate the sensors you have installed on your vehicle and then re-transmit the configuration to the logger.

Sensors to be **auto-calibrated** are:

- internal lateral g-sensor
- Gyroscope (for **MXL Pista**, **PRO** and **PRO 05** only)
- Potentiometer distance

Sensors to **calibrate** are:

- mid zero potentiometer
- zero based potentiometer
- gear sensor (see “[How to calibrate a gear sensor](#)”).

To calibrate/auto-calibrate sensors:

- press button “Calibrate” on the top toolbar.

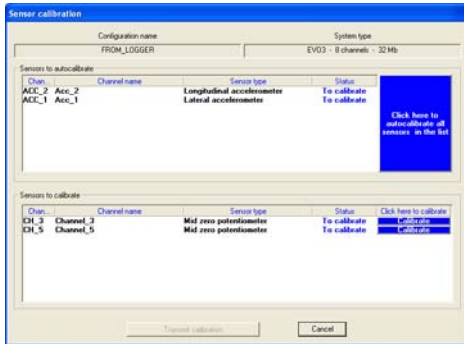

Calibrate / Auto-calibrate sensor

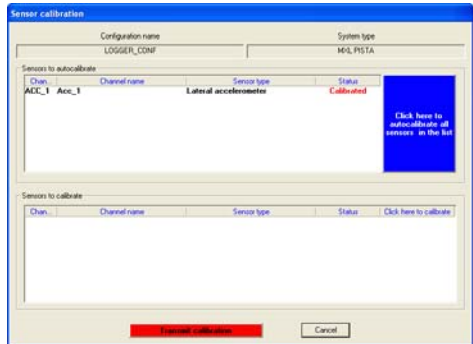

Sensor Calibrated

- Keep the vehicle as horizontal as possible (if your vehicle is a bike leave it on the prop stand) and set the potentiometer in its “0” position.
- Press “Click here to auto-calibrate all sensors in the list” if you are going to auto-calibrate accelerometer, gyroscope or potentiometer distance;
- Press “Calibrate “ button corresponding to the sensor you are going to calibrate if the sensor is Mid Zero potentiometer, Zero Based Potentiometer or Gear Sensor;
- Follow the instruction prompted on your Pc monitor if some appears;
- Calibration status turns from “To calibrate” in “Calibrated”.
- Transmit the configuration to the logger.

Please note that calibration / auto-calibration procedure is fundamental to acquire correct data.

9.2.1 – How to calibrate a Gear sensor (Potentiometer)

To calibrate a gear sensor:

- Set “Potentiometer Channel 8/12” in System Configuration Layer
- Click on “Calibrate” button on the top toolbar
- Press “Calibrate” button corresponding to Gear Sensor
- The following screenshot appears:

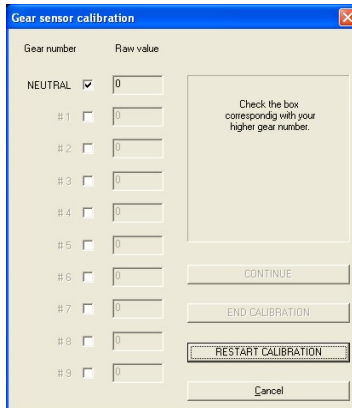

Gear number	Raw value
NEUTRAL <input checked="" type="checkbox"/>	0
# 1 <input type="checkbox"/>	0
# 2 <input type="checkbox"/>	0
# 3 <input type="checkbox"/>	0
# 4 <input type="checkbox"/>	0
# 5 <input type="checkbox"/>	0
# 6 <input type="checkbox"/>	0
# 7 <input type="checkbox"/>	0
# 8 <input type="checkbox"/>	0
# 9 <input type="checkbox"/>	0

Check the box correspondig with your higher gear number.

CONTINUE

END CALIBRATION

RESTART CALIBRATION

Cancel

- Check the box corresponding to the first engaged gear number (neutral);
- Engage the neutral gear;
- Press “Continue” button;
- Engage the first gear;
- Press “Continue” button;
- Repeat this procedure until the last gear has been engaged;
- Press “End Calibration” button;
- Transmit the calibration to your **MXL**.



9.3 – How to calculate gears

- Set “Calculated” or “Calculated with neutral signal: Channel 8/12” in System Configuration window (all depends on if you have or not a neutral sensor installed on your vehicle).
- The procedure is made of **three steps: activation, learning lap and calculation.**
- Gear calibration proceeding is made using two inputs: **RPM** and **speed**. These two channels should be correctly configured and the related sensors installed correctly.
- If the logger has more than one speed input, the gear calibration procedure will use as reference speed the one shown on display.
- We recommend using the speed of the driving wheel as reference one, since wheel slip can skew the results. You can use non driving wheel speeds but you should pay more attention to prevent the wheels from sliding or being blocked during the learning lap.

9.3.1 – Activate gear calculation proceeding

To start this function or to reset previous values and re-start gear calculation you need to use **MXL** keyboard:

- press [**MENU/←←**] button until you see: **GEAR Calibration**
- press [**MEM/OK**] button and you will see: **calculated gear**
- press [**MEM/OK**] button and set maximum engaged gear number using [**←←**] and [**→→**] button;
- confirm the inserted value pressing [**MEM/OK**] button;
- Quit MENU mode pressing [**VIEW**] button. The display shows:
running GEAR CAL
- Gear calculation procedure has started.



9.3.2 – Learning lap

After the proceeding activation:

- Run a track lap (learning lap)
- Engage all gears.
- Keep each gear engaged for at least 5-6 seconds.
- Drive in a smooth way avoiding sudden accelerations or wheels blocks during brakes; let the engine keep RPM gradually and keep brakes as long as possible too, in line with track characteristics and traffic situation.
- If your reference speed comes from a non driving wheel, pay particular attention to your driving style to reduce sliding between driving wheels and non driving ones.
- Please go to the pit lane after the learning lap and switch the engine off.
- **Warning: please totally avoid** “revs” while the vehicle is moving; **avoid** running through the pit lane with friction engaged.
- If the vehicle needs it you **can** press the accelerator before switching the engine off **but when the vehicle is completely stopped**.



9.3.3 - Gear calculation

After engine switch off gear calculation proceeding starts automatically. During this period

- **LED AL1** blinks
- After a few seconds (duration of the calculation depends on learning lap length) **LED AL1** switches off
- the display no longer shows **running gear cal**

All **AIM** systems allow gear calculation to proceed also if you need to switch the engine off. In this case you only need to power the **MXL** on and the calculation re-starts automatically with the recorded values. In this case the calculation takes more time and you see blinking before **LED AL2** and after **LED AL1**.

WARNING: do not move the vehicle and do not switch the engine on during gear calculation. If you move the vehicle the logger may record values that can confuse the calculation.



9.3.4 - Final suggestions

The gear calculation procedure is only possible due to the measurement of the angular speed of the driving shaft and of the driving wheel. When friction is completely engaged between the two speeds, a ratio is defined mechanically by the engaged gear. If the friction slides this ratio is no longer determinable. If reference speed comes from a non driving wheel, the sliding between driving wheel and non-driving one due to accelerations and brakes implies an error in the gear computation. This is why we recommend you to drive as smoothly as possible during learning lap and to use a driving wheel for the reference speed.

10 – What is Online option

“Online” button it is used to check that everything works properly.

After sensor calibration / auto-calibration, we suggest you to enter “Online” mode (ensure that **MXL** is connected to the PC and powered on).

- press “Online” button in **Race Studio 2** top toolbar

Online window details:

Logger type: MXL PISTA Firmware version: 14.43 Total frequency: 121 (Hz)

N	Channel i...	Channel name	Sensor type	Meas...	Measure
1	RPM	Engine	Engine revolution speed	rpm	0
2	SPD_1	Speed_1	Speed	km/h .1	0.0
3	CH_1	Channel_1	Generic linear 0-5 V	V .1	0.0
4	CH_2	Channel_2	Generic linear 0-5 V	V .1	0.1
5	CH_3	Channel_3	Generic linear 0-5 V	V .1	0.0
6	CH_4	Channel_4	Generic linear 0-5 V	V .1	0.0
7	CH_5	Channel_5	Generic linear 0-5 V	V .1	0.0
8	CH_6	Channel_6	Generic linear 0-5 V	V .1	0.0
9	CH_7	Channel_7	Generic linear 0-5 V	V .1	0.0
10	CH_8	Channel_8	Gear potentiometer	#	0
11	CALC_GEAR	Calculated_Gea	Calculated Gear	#	0
12	ACC_1	Acc_1	Lateral accelerometer	g .01	0.12
13	LOG_TMP	Datalogger_Tem	Cold joint	°C	29
14	BATT	Battery	Battery	V .1	15.0

Right panel status:

- Show ADC counts** (button)
- Battery**: V 14.985
- Memory**: 0 % (Logger isn't storing data)
- Lap marker**: 0.00.00.000 (Waiting.. - Last lap nr.0)
- Logger-PC link**: Communication line: OK
- Configuration status**: Configuration is OK
- Exit** (button)

Online window shows:

- On top: Logger Type, Firmware Version, Total Sampling Frequency
- Central: Channels Table with all channels settings
- On the right: “Show ADC counts” button (mainly used by service staff)

- Battery voltage
- Memory status
- Lap Marker
- Logger – Pc Link (Status of USB communication connection)
- Logger Configuration Status
- “Exit” button
- If this warning message appears:

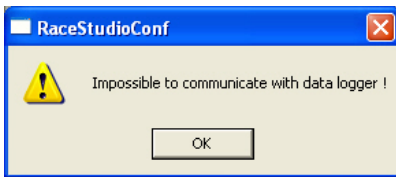

- check that the USB cable is correctly plugged both in the PC USB port and in **MXL** USB port and try again.



11 – MXL Keyboard function (Data recall and clearing, backlight, set date and time, GPS Module, calculated gears, shift lights, demo mode etc.)

Through **MXL** keyboard you can:

- Recall recorded data
- Enable / disable the backlight
- View / clear total running
- View odometer
- Set beacon and splits for GPS Laptimer (see chapter 11)
- Set date and time
- Set the shift lights
- View Logger Firmware Version and serial number.

11.1 – How to recall recorded data

When a test session is finished you can recall recorded data using your **MXL** keyboard. To recall recorded data:

- **MEM** → the display shows Best lap time of the last run with RPM and speed Max value and Channel 1 and Channel 2 max value.
- With “<< / >>” buttons you can scroll all laps and runs with Lap and Split times, RPM and speed max value and channels 1 and 2 max value.

11.2 – Other keyboard function

How to enable / disable the backlight

→ “**MENU**” → Night Vision on/off → “**OK/MEM**” button to enable/disable the backlight → “**Quit/VIEW**”.

To enable/disable it while running → “**MENU**” button.

Backlight setting is stored by the gauge: at each power on it restores the setting in use the when the power was last turned off.

How to set GPs beacons and splits

→ See chapter 12

How to view/clear total running

→ “**MENU**” **twice** → Total run km on the left and Total run hours and minutes on the right

→ “**OK**” to clear → “**OK**” to confirm → “Total are cleared”

How to view odometer (not resettable)

→ “**MENU**” **three times** → Odometer in Km is shown on the right

How to set date and time

→ “**MENU**” **four times** → Set date and time → “**OK**” → “Set **Hour**” → “<< / >>” buttons to set hour → “**OK**” → “Set **Minute**” → “<< / >>” buttons to set minute → “**OK**” → “Set **Year**” → “<< / >>” buttons to set year → “**OK**” → “Set **Month**” → “<< / >>” buttons to set month → “**OK**” → “Set **Day**” → “<< / >>” buttons to set day → “**OK**” → “Set **weekday**” → “<< / >>” buttons to set weekday → “**OK**” → “**Quit / view**” button

How to start / reset gear calibration (only if set during [system configuration](#))

→ “**MENU**” **five times** → “Start Gear Calib” → “**OK**” → “Press OK to clear”⁸ → “**OK**” → “Save new config” → “**OK**” → Display shows “Running Gear cal” on the static string (see “[How to Calculate gear](#)” chapter).

How to set the shift lights

⁸ Press OK to clear gear calculation values used at present.



→ **"MENU" six times** → "Shift Light" → **"OK"** → The **first led** on the right and on the left on top of **MXL** switch on and display shows "Insert RPM value" → "<</>>" buttons to set RPM value (accepted values are from "0" to "22.000") → **"OK"** → The **second led** on the right and on the left on top of **MXL** switch on and display shows "Insert RPM value" → "<< >>" buttons to set **and so on until all leds are set** → **"OK"** → Display shows "save new config" → **"OK"** → **"Quit/VIEW"** button

System information

→ **"MENU" seven times** → Display shows **Firmware version** on the left and logger **serial number** on the right

How to run MXL in demo mode/stop demo mode

- Switch on the logger →simultaneously press **"MENU/<<"** and **">>"** buttons.
- To stop demo mode switch off the gauge.

12 – GPS Module and the new Lap Timer function

This new external expansion module for **MXL** allows you to show and record lap/split times without installing any beacon receiver nor transmitter. You only need a GPS Module with firmware version 35.13 or later connected to an **MXL** with firmware version 14.86.22 or later.

The first operation to be done is setting GPS beacons for the complete lap and for the splits giving the Module correct and coherent instructions. This allows it to capture lap/split times.

Note: this operation is to be done before the race and it is only sufficient to do it once for each track. The logger automatically recognizes the track the following time.

12.1 – Preliminary operation

GPS Laptimer can detect both lap and split times but, being an external expansion that works as a slave device, its detection mode with or without splits depends on the configuration of its master logger, in this case **MXL**. This means splits have to be set via software.

- Set Lap segments in Lap box (shown on the right) of Race Studio 2 system configuration window (Par. 8.2.4)
- Transmit the configuration to the logger

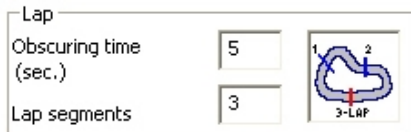

Show odometer instead of lap time

12.2 – How to set GPS beacons

To set start/finish line and splits position of GPS Module please follow this proceeding (it can be done both with the engine switched on or off):

- Ensure GPS Module is correctly connected to **MXL**
- Press “**MENU**” button on **MXL** keyboard.
- The system shows a menu with backlight and GPS options
- Select “Set GPS beacon” using “>>/<<” buttons
- Press “**OK**” button

- **MXL** asks you to set start/finish line
- Go to the point you want to consider as start/finish line and press “**OK**” button
- Start/finish line position is saved.



Once start/finish line is set, if the system is configured to capture splits, the page shown on the right appears:

- go to the point of the track you want to consider as split;
- press “**OK**” button.



Once the configuration ended, the system shows automatically start page and you will be able to record times.

“TRK” circled in the figure on the right, confirms that the system recognised the track and is ready to record lap and split times.



To cancel the proceeding you need to switch **MXL** off and then on again.

Note: in case of low or missing satellite signal MXL will ask you to set beacons again.

12.3 – Additional functions

GPS Module can record up to 50 track configurations. Once saved, the circuit will be automatically recognised when you enter that track with your MXL connected to GPS Module.

Warning: MXL with GPS lap timer manages signals coming from an optical receiver too. We thereby suggest you to disconnect the traditional infrared receiver from MXL to avoid risk of lap times duplications.

12.4 – GPS Manager software

Thanks to GPS Module you will be able to create lap and split signals in any point of the track. You can use this software to synchronize GPS Module with your Pc. With GPS Manager you can:

- Move lap/splits configurations from GPS Module to your Pc
- Move lap/splits configurations from your Pc to GPS Module

The figure below shows GPS Manager software main window.

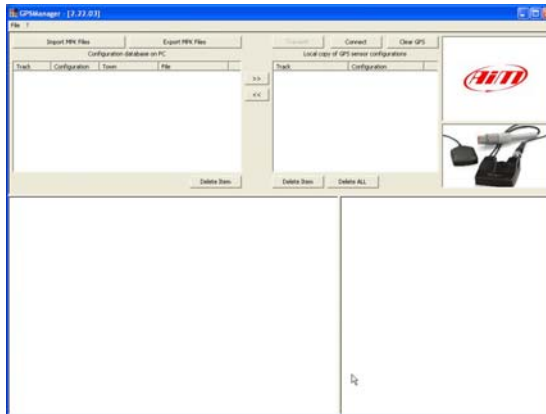

Top left is “**Configuration database on Pc**” window, more in detail below; it shows a list of all the available track configurations. This list is automatically loaded when you run the software.

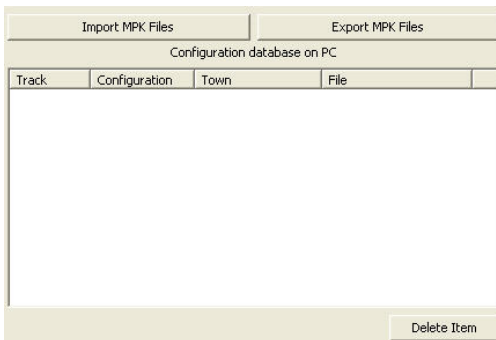

Over this window are two buttons:

- “*Import MPK files*”: imports a configuration in the Pc Database from an external electronic support (an USB key for instance)
- “*Export MPK files*”: exports a configuration from the Pc database to an external electronic support (an USB key for instance) so to be able to re-import it in another Pc.

Under the window is “*Delete Item*” button, that allows you to delete one by one the configurations from the Pc Database.

Between the two windows that shows configurations on the Pc and locally on the GPS are two **displacement buttons** that are used to move the configurations from the Pc Database to the GPS Module one and vice versa.



- “>>” button moves the configurations from the Pc database to GPS Module one.
- “<<” button moves the configurations from the GPS Module database to the Pc one.

Note: the configuration is moved from one database to the other only in the software and GPS Module is really synchronized only when “*Transmit*” button is pressed.

Moving of a configuration from **GPS Module database to Pc one** can lead to three different situations:

1. The configuration has just been created on GPS Module. A window appears and asks you to insert track and configuration names and the configuration will be copied in the database.
2. The configuration on GPS Module has already been copied in Pc database. A window appears and asks you to insert the name of the configuration: filling it in and pressing “OK” button you will add a configuration to the Pc database. Pressing “OK” without inserting any name nothing changes.
3. The configuration on GPS Module has a name but there is no copy of it in the Pc database. Pressing “OK” button you will insert a new configuration in the Pc database.

The picture below shows the window where to insert track name and track configuration name.

- **File name** is by default set as track and configuration name unless user enables “*File Name*” checkbox and inserts file name.
- **Town name** is by default set as track one but it can be user defined checking “*Town*” checkbox and filling in the desired name.

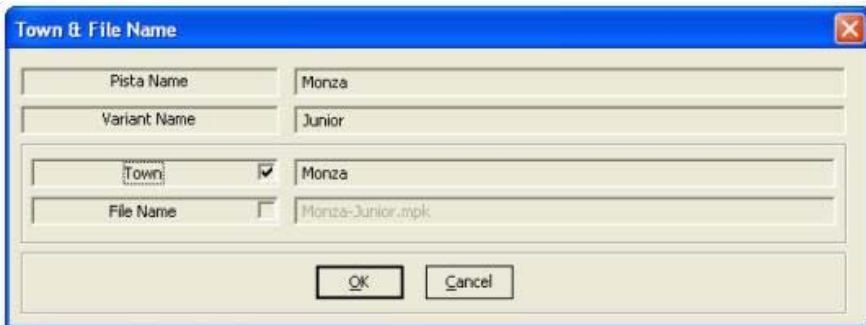

Pista Name	Monza
Variant Name	Junior
<input checked="" type="checkbox"/> Town	Monza
<input type="checkbox"/> File Name	Monza-Junior.mpk

OK Cancel

Top central, “**Local copy of GPS sensor configurations**” window, see below, shows a list of all track configurations stocked in the GPS Module memory. This list is loaded on user’s demand.

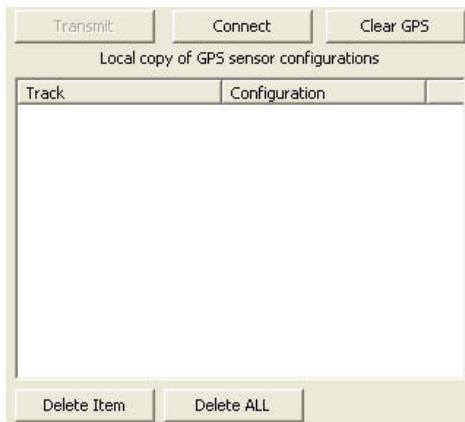

Over this window are three buttons.



- “*Transmit*” button is to copy the configurations from the GPS Module list into the GPS Module memory. The user receives a confirmation message because this operation modifies the content of the memory of the Module.
- “*Connect*” button is to load the GPS Module list. The software copies in the list all configurations of the Module memory.
- “*Clear GPS*” button is to completely erase the GPS Module memory. The user receives a confirmation message because this operation completely erases the Module memory.

Under this window are two buttons.





- > “Delete Item” buttons allows you to delete one by one the configurations from the Pc Database.
- > “Delete ALL” button allows you to delete all the configurations from the Pc database. **Warning:** pressing this button you will delete the configurations only form the local copy of GPS Module memory; please use “Transmission” button to really delete GPS Module memory.

Top right the software shows two window: top one shows AIM logo and bottom one shows an image of GPS. When GPS is connected to **MXL** AIM logo will be replaced by an image of **MXL**. The system is telling you that GPS is communicating with an **MXL** logger.





12.5 – Typical use of GPS Manager software

Typical use of GPS Manager software expects you to go on the track with GPS Module connected to **MXL** and set lap and splits (if configured). Once this procedure completed, GPS Module will be able to record lap and split times of that track forever.

If you wish to copy the lap/split configuration you created from one GPS Module to another follow this procedure:

1. Connect GPS Module (1) to the Pc
2. Run GPS Manager software
3. Press “*Connect*” button
4. Press “<<” button to copy the configuration in the Pc database
5. Disconnect GPS Module (1) from the Pc
6. Connect GPS Module (2) to the Pc
7. Press “*Connect*” button
8. Press “>>” button to copy the configuration from the Pc Database to the Local copy of GPS sensor configurations
9. Press “*Transmit*” button



13 – My **MXL** Memory

All **MXL** models have non-volatile internal RAM memory.

Memory dimensions:

- **MXL Strada** 128 kb
- **MXL Pista** 8 Mb
- **MXL PRO** 8 Mb
- **MXL PRO 05** 16 Mb

MXL round memory stores up to 500 laps in two blocks made of 250 laps so when lap number 501 is recorded laps from 1 to 250 are deleted. This means:

- you always have your **last 250 laps** in your logger memory
- your lap memory **never fills up**

Memory Architecture:

MXL memory is divided into two parts:

- first part stores sampled channels and when it fills up the **MXL** display shows “MEMORY FULL”
- second part is round and stores lap and split times, RPM, Speed and channels 1 and 2 max values for at least your last 250 laps and never fills up.

Memory working mode:

- All **MXL** have a maximum storage time at 380Hz total sampling frequency.
- Increasing sampling frequency maximum storage time diminishes.
- **MXL Strada / Pista / PRO** have 3 hours max sampling time at 380Hz total sampling frequency; 30 minute max sampling time at 2kHz total sampling frequency.
- **MXL PRO 05**: has 6 hours max sampling time at 380Hz total sampling frequency; 60 minute max sampling frequency at 2kHz total sampling frequency.



14 – **MXL** Maintenance

MXL does not need any special maintenance.

Provided that adequate care is taken of display unit and components, the only suggested maintenance is periodical software and/or firmware upgrading when upgrades are released by **AIM** (periodically check www.aim-sportline.com).

To upgrade the software/firmware:

- connect to www.aim-sportline.com
- go in “Software download” page
- check if any software and/or firmware upgrade has been released
- download it
- run it
- follow the instructions prompted on your Pc monitor.

15 – How to download and save test values

Once a test session has finished, you can download data stored in the logger memory and store them in a database management system.

To **download** data:

- switch on your Pc
- run **Race Studio 2** software
- connect your **MXL Pista / MXL PRO / MXL PRO 05** to the PC USB port through the USB cable
- switch the logger on.
- click on “Download” button on **Race Studio 2** top toolbar
- this window appears:

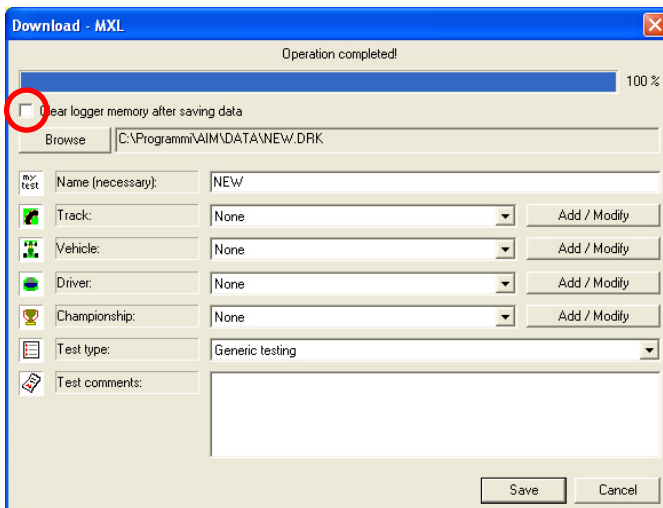

- In the window's upper part is a “waiting-bar” which informs you on the download percentage status.

- Below the waiting-bar is a checkbox (circled in the figure) that allows you to “Clear logger memory after saving data”. It is enabled by default to avoid filling the logger memory, since this will cause data acquisition to stop. If you do not want to clear logger memory after download disable it (you may need to download data on more than one Pc). Use with care.
- After data download “Save” button enables. If you press it without specifying file name and destination folder the file is automatically saved in the default folder “X:\Program files\AIM\DATA” (where “X” is the hard drive where **Race Studio 2** is installed) with the default name “new.drk”.
- To save the file with another name and/or in another folder, insert file name in “Name” box and press “Browse” button: save as window appears.

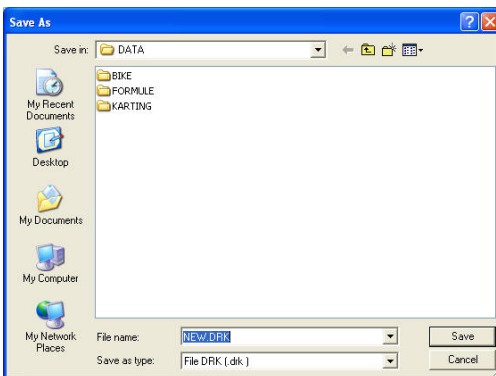

- If you unintentionally close this window without saving the data you will see the following warning:

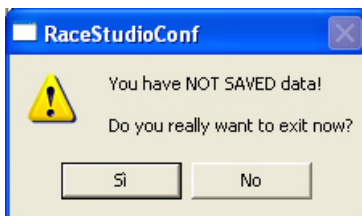

- If you have already saved files automatically (without specifying file name and destination folder) and you try to save others, the system gives you the choice between an automatic numeric file name and a manual file name.

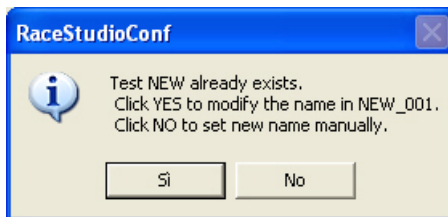

- If you disabled “Clear logger memory after saving data” checkbox, when download operations are finished the system asks you whether to clear the logger memory or not. Normally you would clear the memory to prevent it from filling up with future data, however you would not clear it if you wanted to download the data to another computer.



15.1 – How to insert the test in a database

Race Studio 2 has a test storage system based on databases.

This storing system allows you to save files by specifying 5 properties: vehicle, driver, track, championship and test type. This information is saved together with the test file, and allows you to group files into self-defined categories identified by these 5 properties. When saving a new test file, you can insert it in the previously set database properties or create a new property name.

To **insert a test in the database** after data download:

- click on “Browse” button
- enter file name;
- click on “Add/Modify” button corresponding to “*Vehicle*” properties. This window appears;

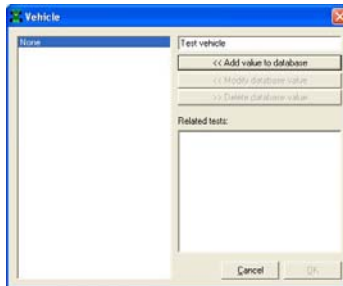

- If the database is empty or you wish to create a new property name, fill the upper right box with the new Vehicle name and then click “Add value to database” button. In the left column the new category appears and “OK” button becomes enabled: click on it.

- If the desired property name appears in the existing database categories (left column), you can select it single-clicking on the name and click “OK” button;
- If you do not wish to specify any category, the file is saved in the database and all attributes set to “None”.
- Please, repeat this procedure until all 5 categories have been filled.
- Once all the attributes have been set, like in the following image, please click on “OK” button.

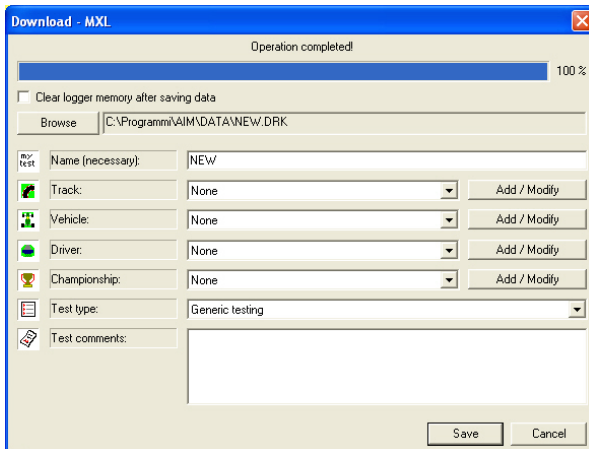

Property	Value	Action
Name (necessary):	NEW	
Track:	None	Add / Modify
Vehicle:	None	Add / Modify
Driver:	None	Add / Modify
Championship:	None	Add / Modify
Test type:	Generic testing	
Test comments:		

16 – How to use Race Studio Analysis (Except for MXL Strada)

Race Studio Analysis is the software developed by **AIM** to analyse data stored in your **MXL**⁹. It is a very powerful instrument to analyze and improve vehicle and driver's performances. It allows you to create track maps, compare different laps, plot channels versus time, distance or frequency, has a data animation option, an histograms option and useful math channels.

To run **Race Studio Analysis**:

- click twice on the corresponding icon (shown on the right), that you find on the desktop of your PC monitor.
- If you are using **Race Studio 2**, click on “Analysis” tab, or on “Start / Program Files / AIM / Race Studio 2 / Race Studio Analysis” or press “F5” on your PC keyboard



Race Studio
Analysis

Once **Race Studio Analysis** is launched, the following window appears:

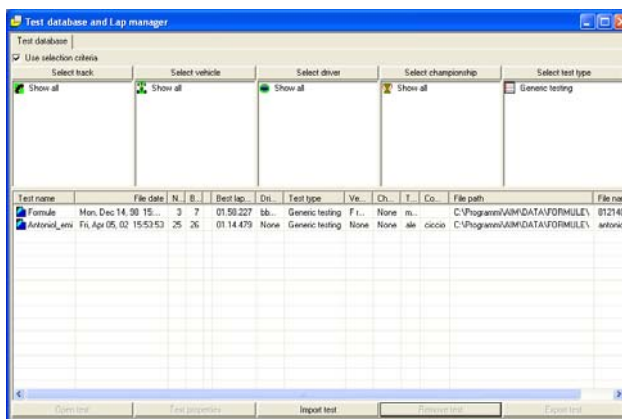

The “Test database and lap manager” window is made of different layers and allows you to load/unload a test and to manage the database and the loaded tests.

⁹ **MXL Pista / MXL PRO / MXL PRO 05** only; **MXL Strada** does not download data.

16.1 – How to open a test

You can choose a test to open in two ways: using the 5 selection criteria (recommended) or not.

Opening a test using the 5 selection criteria

- enable “Use selection criteria” checkbox. In the lower part of the “Test database and Lap manager” window you can see all tests included in the database and, in the upper part, database categories and sub-categories.
- click on the selection criteria you want to use (“Select track”, “Select vehicle”, etc...): the corresponding selection window appears.

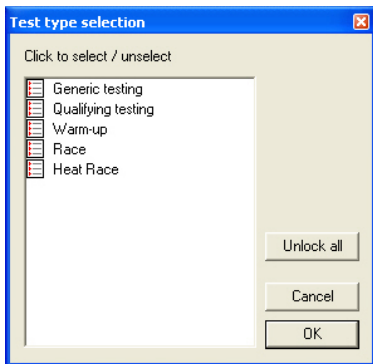

Test type selection – no type selected

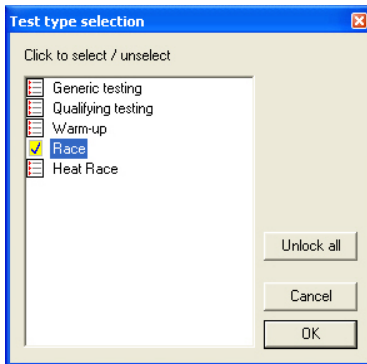

Test type selection – one type selected

- To choose a database sub-category, enable it as shown in the figure on the right; you can enable more than one sub-category. Please repeat this operation for all criteria. Tests not belonging to these categories are not shown.

- To open a file choose the category and double click on the file or right click on the file and choose open option.

Open a test not using the 5 selection criteria

- disable “Use selection criteria” checkbox.
- you can choose a file to load in three ways: double-click on it, select it and then press button “Open test” on the left of the top toolbar or right-click on the file name and choose “Open test” option.

The screenshot shows a window titled "Test database and Lap manager" with a menu bar containing "Test database", "1 - Formule", and "2 - Antoniol_emi". Below the menu bar is a toolbar with buttons for "Advanced information", "Close test", "Export to Excel", and a checked checkbox for "View only enabled laps". A secondary toolbar contains buttons for "Show lap", "Hide lap", "Enable lap", "Disable lap", "Insert lap", and "Merge lap to next". The main area is a table with columns: "L...", "Lap time", "% on ref...", "Time fro...", "Lap cause", and "Last split". The table contains six rows of data, with the first four rows having a green icon in the "L..." column and the last two rows having a yellow icon.

L...	Lap time	% on ref...	Time fro...	Lap cause	Last split
1	01.17.445	65.51 %	06.14.666	(Lap marker)	
1	01.16.006	64.29 %	07.32.111	(Lap marker)	
1	01.15.487	63.85 %	10.03.636	(Lap marker)	
1	01.16.238	64.48 %	15.21.591	(Lap marker)	
2	01.14.682	63.17 %	25.22.015	(Lap marker)	
2	01.14.479	63.00 %	26.36.697	(Lap marker)	

You can open up to 4 different tests at one time in order to make comparisons between many different laps. In the screenshot reported above you can see three layers: Test database layer and two test layers (“1-Formule”, and “2-Antoniol_emi”). To select a particular lap, you may double-click on it or single-click and choose “Show lap” function. When the lap is selected the green icon located on the left of the lap number turns yellow.

16.2 – How to plot a channel

Race Studio Analysis allows you to plot recorded laps and sampled channels versus time, distance and frequency.

How to plot RPM and Speed vs. time

- click on “RPM” and “Speed” in the “Measures and laps” toolbar (to show this toolbar click on “View / Measures toolbar” and it appears on the left part of **Race Studio Analysis** window)
- click on “Plot vs. time” icon. 

How to plot any channel vs. time

- use “CTRL+F1” shortcut or click “View \ Plot vs. time” command.

The following figures show the “Measures and laps” toolbar (first figure) and speed and RPM diagram during a lap (second figure).

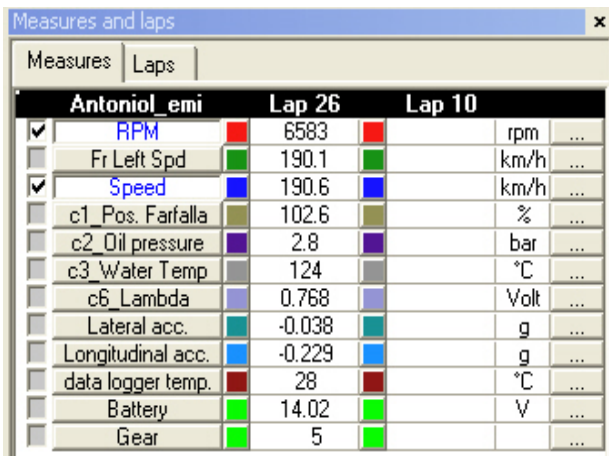

	Antoniol_emi	Lap 26	Lap 10		
<input checked="" type="checkbox"/>	RPM	6583		rpm	...
<input type="checkbox"/>	Fr Left Spd	190.1		km/h	...
<input checked="" type="checkbox"/>	Speed	190.6		km/h	...
<input type="checkbox"/>	c1_Pos. Farfalla	102.6		%	...
<input type="checkbox"/>	c2_Oil pressure	2.8		bar	...
<input type="checkbox"/>	c3_Water Temp	124		°C	...
<input type="checkbox"/>	c6_Lambda	0.768		Volt	...
<input type="checkbox"/>	Lateral acc.	-0.038		g	...
<input type="checkbox"/>	Longitudinal acc.	-0.229		g	...
<input type="checkbox"/>	data logger temp.	28		°C	...
<input type="checkbox"/>	Battery	14.02		V	...
<input type="checkbox"/>	Gear	5			...

Measures and Laps toolbar

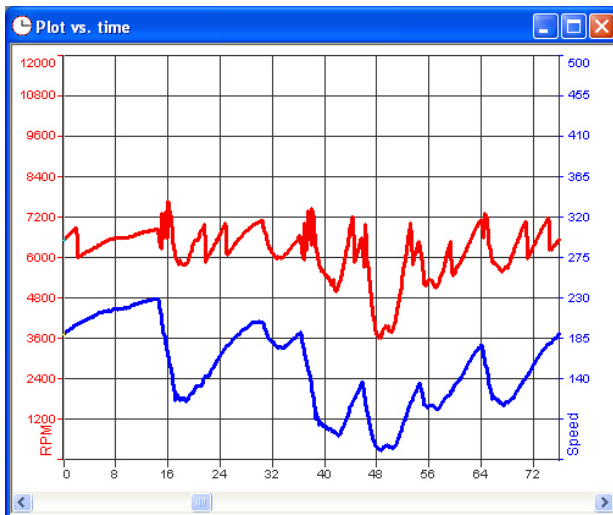

Speed (blue) and RPM (red) diagram during a lap

How to add a sampled channel to the graph

Click on the desired channel name inside the “Measures and laps” toolbar.

How to change the graph colours

Click on the coloured boxes column to set the desired colour for each recorded lap and for each sampled channel.

How to add the scale to the graph

Enable the checkbox corresponding to the desired channel name.

How to load and use “Measure information” dialog window

Click on the pushbuttons of the last right column of the “Measures and laps” toolbar: this window allows you to change channel name, plotting scale and unit of measure; you can also amplify and shift the diagram using the “Value=(Value*A)+B” option where A is the amplification factor (from -1000 to +1000), while B is the shift factor (from -500000 to +500000).

The following image shows the “Measure information” dialog box.

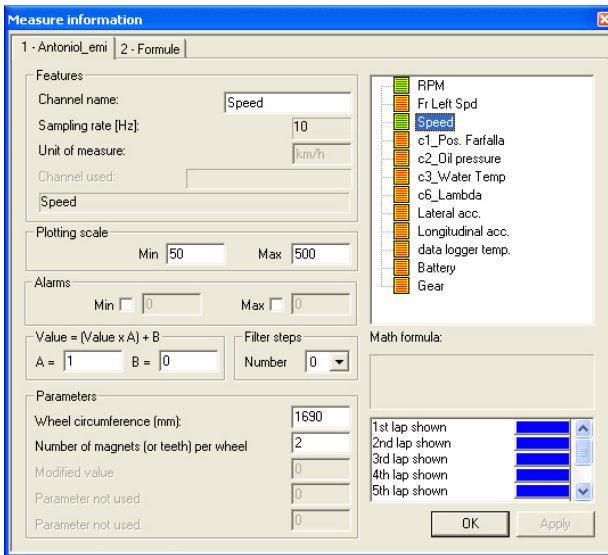

Please note: choosing a channel from the channel list in the upper right box, the parameters you can set (i.e. RPM multiply factor, wheel circumference, pulses per revolution, etc...) will appears in the lower left corner.

16.3 – How to create a track map (Pista / PRO / PRO 05 only)

The internal lateral G sensor and/or external gyroscope (only available for **MXL Pista**, **PRO** and **PRO 05**) allows you to create a track map on your PC.

To create the track map:

- load a test
- select a good lap (labelled as “Lap marker” in the Lap cause column of the Lap manager dialog box)
- press “Map \ New” from the Command toolbar or “Shift+F4” keys: this window appears (Sample map shown, yours may look different):

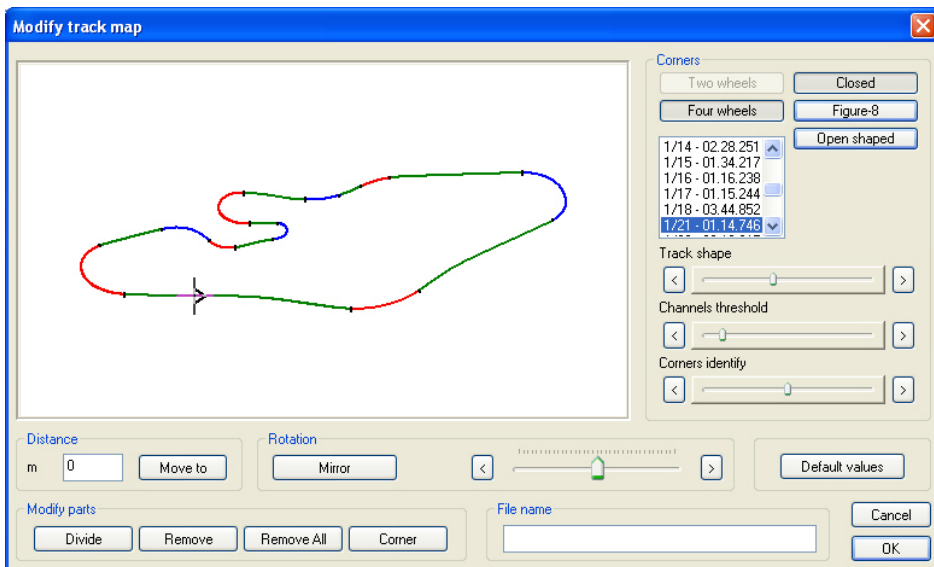

- Through “Corner” box, “Distance” Box and “Modify parts” box you can draw your map.
- Press “OK” button to save your map or “Cancel” button not to

Corners Box:

- Select you vehicle wheels number (two or four wheels)
- Select the track type (Closed, Figure 8 or Open shaped)
- “Track Shape”, “Channels threshold” and “Corners Identify” allow you to set the track shape using the related sliders.

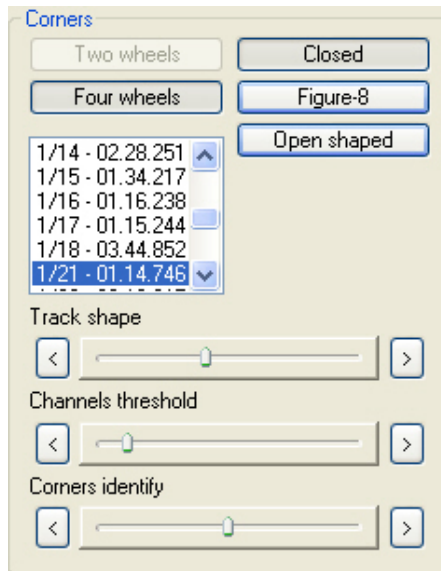

File name Box:

- Insert the name you want to give to your map.

Distance Box:

- Set the distance in meters you want to move to and press “Move To” button

Rotation Box:

- use “Mirror” button to rotate your map 180°
- use the slider to set a custom rotation angle

Modify parts box:

- Divides a split into two separate splits;
- Removes an intermediate split or all;
- Changes a circuit part from Straight (green line) to Corner (blue / red lines) or vice versa. Note: it is not possible to have two consecutive straights; otherwise the following warning window appears

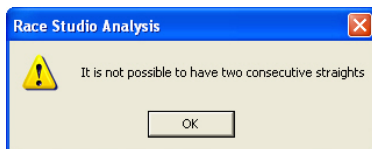

- You have to keep a minimum distance between two sections of the truck, otherwise this warning message appears:

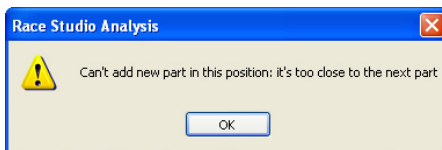

16.3.1 – Possible track map creation troubleshooting

If this warning message appears.



- select a “Good lap”, labelled as “Lap marker” in the Lap cause column of the Lap manager dialog box, and de-select the previously used lap (double click on the lap number).
- Select a lap without many skids.
- Verify that the correct vehicle type (2 or 4 wheels) in the “Modify track map” window is set.
- Verify that the values stored in both speed channel and lateral acceleration one are sensible: lateral acceleration has to be near to 0 in the straight line, while speed must be greater than 0 and must not have high or low peaks.
- If lateral acceleration or gyroscope signal in the straight line is not quite near to 0, it is probable that the lateral accelerometer (or gyroscope) has not been auto calibrated. You can solve this problem summing or subtracting a fixed value (see “Measure Information” dialog box) in order to have 0 in the straight line. **Before starting a new test run remember to calibrate the internal lateral accelerometer.**

Appendix “A” – Installing the H₂O Thermo resistor

The H₂O Thermo resistor can be installed in the inline water fitting (sold separately). Shown below is how to install the Water Thermo resistor (M5 type).

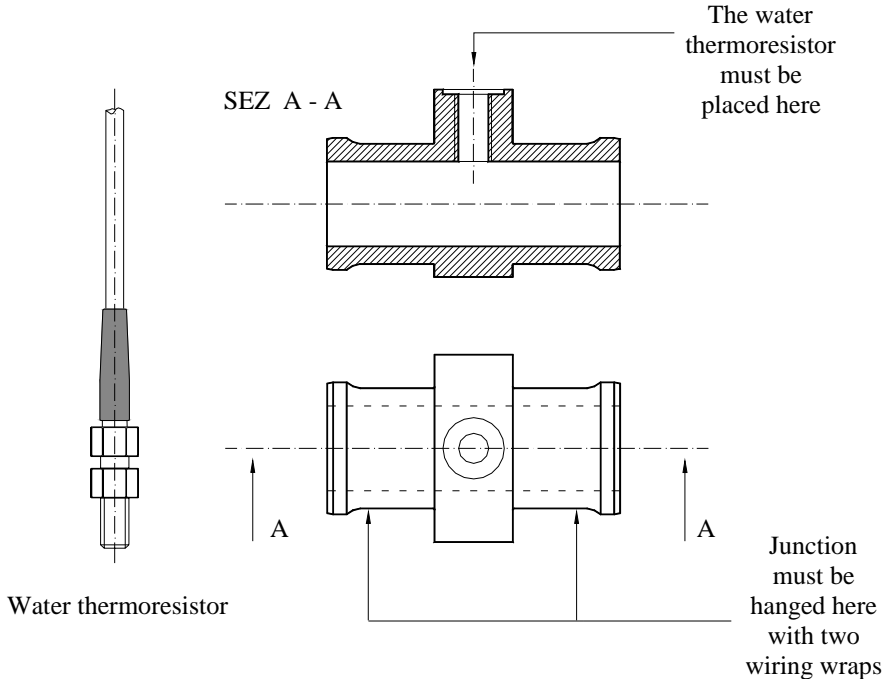

Appendix “B” – Installing the EGT Thermocouple

The Exhaust Gas Thermocouple (EGT) should be positioned inside the exhaust header at a distance of 150 mm (5.9 inches) from the exhaust port. Shown below is how to correctly install the EGT thermocouple.

Warning: insert the probe in the exhaust gas header between 25% and 50% of its length.

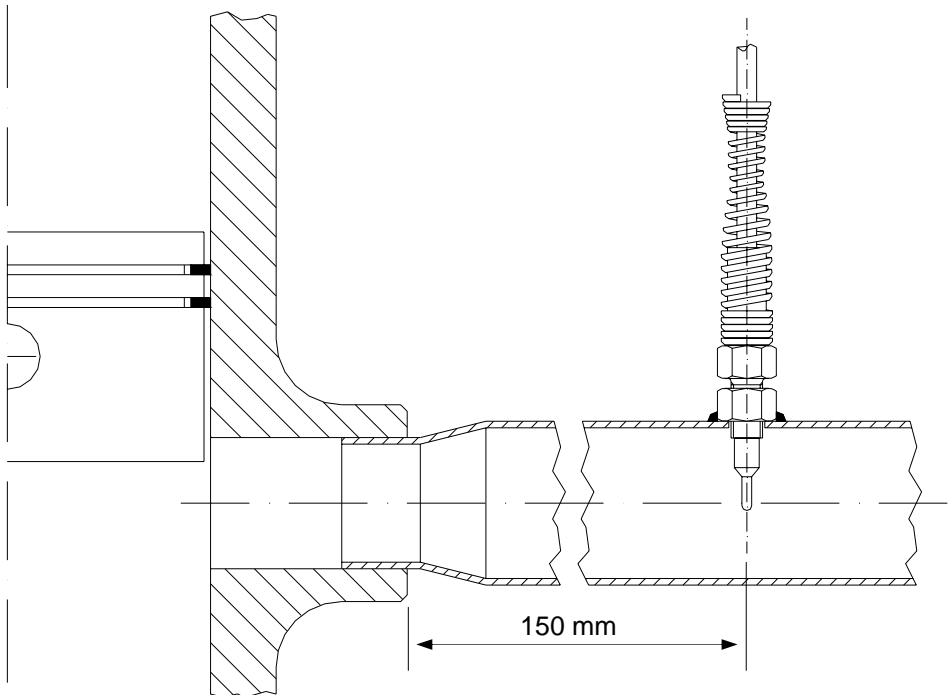

To install the EGT thermocouple:

- Make a 5 mm (0.2 inches) hole inside the exhaust header;
- Weld the little nut to the exhaust header in the point where the hole has been drilled;
- Connect the remaining part of the thermocouple and fix it to the exhaust header screwing it.

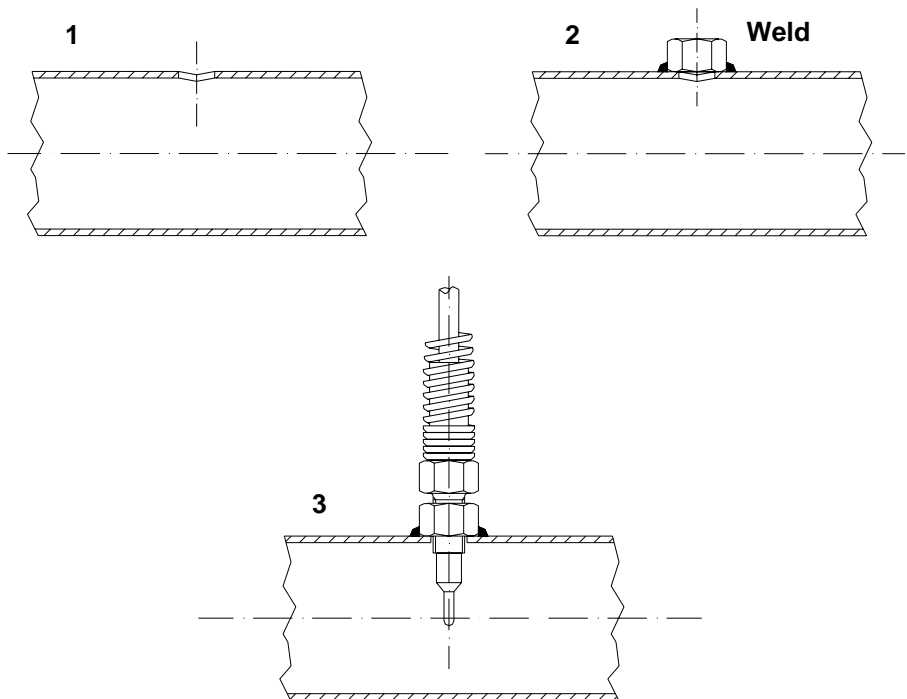

Appendix “C” – Installing the “CAR” speed sensor

The wheel speed sensor for phonic wheel is a “non contact” device and needs a ferrous (magnetic) metal trigger to pass behind the sensor face. **To install the sensor:**

- firmly fix it on a **self-made iron bracket**
- ensure the distance between sensor and phonic wheel is between 0.5 and 2 mm (optimum value: 1 mm) and plug the sensor connector in your **MXL**.

Minimum required **dimensions of the trigger** for the sensor to work properly (with reference to the figure below, that shows the sensor correctly installed) are:

- Tooth height “**A**”: 5.06 mm (0.19 inches)
- Tooth width “**B**”: 2.54 mm (0.1 inches)
- Tooth spacing “**C**”: 10.16 mm (0.4 inches)
- Tooth thickness “**D**”: 6.35 mm (0.25 inches)

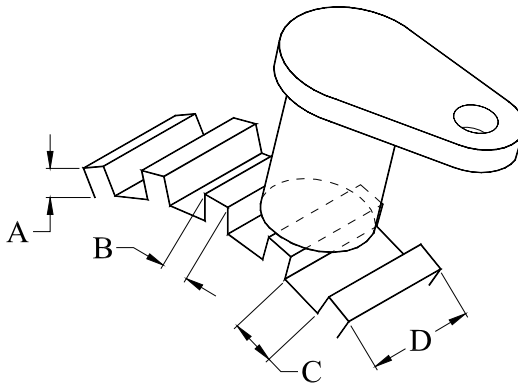

Optimum sensor performance depends on the combination of these variables: trigger material, geometry and speed, sensor trigger gap, magnetic material in close proximity.



Appendix “D” – Installing the “BIKE” speed sensor

The wheel speed sensor for bike installations is a “magneto resistive – non contact” device and needs a magnetic trigger to pass behind the sensor face.

When mounting the sensor (see figure below), please firmly install it on a **self-made iron bracket** and make sure that the distance between the sensor and the magnetic trigger is between 15 and 8 mm (**10 mm is the optimum value**). Once the sensor is installed, please plug the sensor Binder connector in your **MXL**.

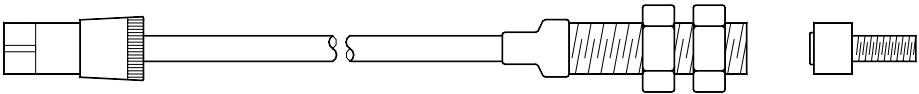

Appendix “E” – MXL Strada technical characteristics

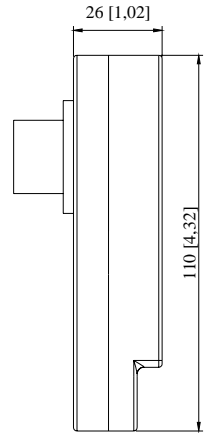
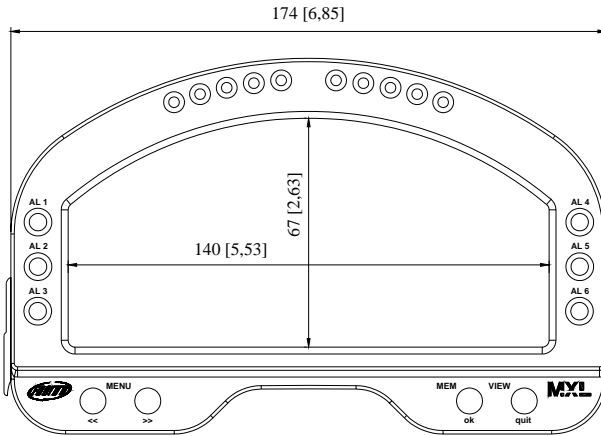

Dimensions in mm (inches)

Connector details (Beacon channel)

Pin	Function	Pin	Function
1	Magnetic Lap	3	+ VB
2	GND	4	Optic lap

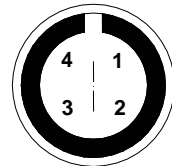

Female 4-pins connector
pinout (external view)

Connector details (CAN for external “Expansion modules”)

Pin	Function	Pin	Function
1	Can 0 +	4	Can 0 -
2	GND	5	9-15 Battery Input
3	+ VB		

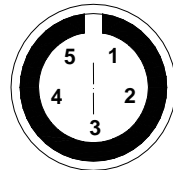

Female 5-pins connector
pinout (external view)

Connectors Details

AMP 12 and 16 pins

(External view on the right)

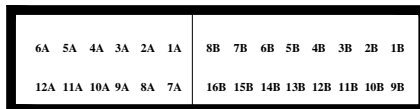

28 pins AMP Connector pinout (external view):
12 pins connector is labelled “A” connector and
16 pins connector is labelled “B” Connector

Connector Details (AMP 12 Pins)

Pin	Function	Pin	Function
1A	GND	7A	USB D-
2A	9-15V Battery input	8A	RPM 150-400 V (coil input) and RPM square wave (> 8 V)
3A	Can 1 - (for ECU interface)	9A	+ VB
4A	Can 1 + (for ECU interface)	10A	GND
5A	RS 232 TX (for ECU interface)	11A	+ VB
6A	RS232 RX (for ECU interface)	12A	Speed

Connector Details (AMP 16 Pins)

Pin	Function	Pin	Function
1B	Analog Input 4	9B	Analog Input 8
2B	V Reference	10B	USB D+
3B	Analog GND	11B	Analog GND
4B	Analog Input 3	12B	Analog Input 7
5B	Analog Input 2	13B	Analog Input 6
6B	V Reference	14B	V Reference
7B	Analog GND	15B	Analog GND
8B	Analog Input 1	16B	Analog Input 5



Technical characteristics

General characteristics	Value
Analog Input channels	8
Speed channel	1
Input channels from ECU	Max 64
Memory Management	Records Lap Times/Max Ch. Values
External power	From 9 to 15 VDC
Voltage Output (V reference)	4,5 V (for potentiometers)
Internal memory	128 Kbytes
ECU Interface	Serial / CAN protocol
PC Interface	300 Kbytes / sec. USB port

Other characteristics	Value
MXL Strada dimensions	174 x 110 x 26 mm
Display dimensions	140 x 67mm
Chassis	Aluminium

Appendix “F” – MXL Pista technical characteristics

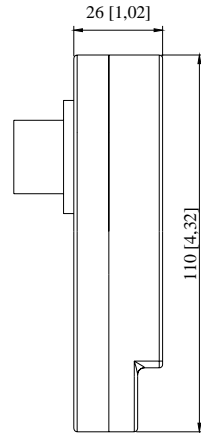
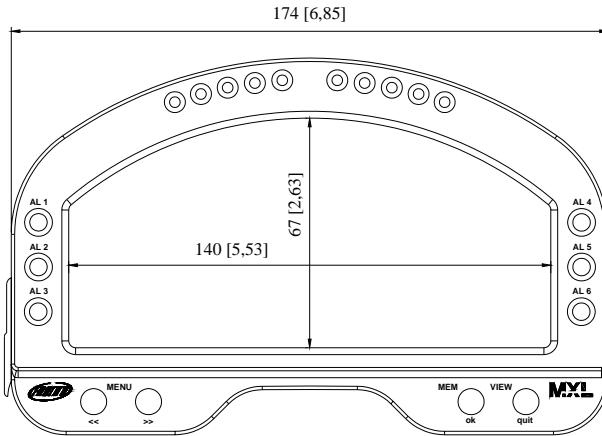

Dimensions in millimetres [inches]

Connector details (Beacon channel)

Pin	Function	Pin	Function
1	Magnetic Lap	3	+ VB
2	GND	4	Optic lap

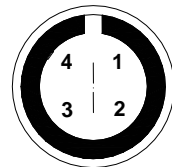

Female 4-pins connector pinout (external view)

Connector details (CAN for external “Expansion” modules)

Pin	Function	Pin	Function
1	Can 0 +	4	Can 0 -
2	GND	5	9-15 V Battery input
3	+ VB		

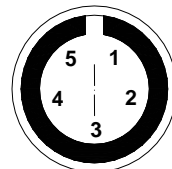

Female 5-pins connector pinout (external view)

Connectors Details

AMP 12 and 16 pins

(External view on the right)

6A	5A	4A	3A	2A	1A	8B	7B	6B	5B	4B	3B	2B	1B
12A	11A	10A	9A	8A	7A	16B	15B	14B	13B	12B	11B	10B	9B

28 pins AMP Connector pinout (external view):
12 pins connector is labelled “A” connector and
16 pins connector is labelled “B” Connector

Connector Details (AMP 12 Pins)

Pin	Function	Pin	Function
1A	GND	7A	USB D-
2A	9-15V Battery input	8A	RPM 150-400 V (coil input) and RPM square wave (> 8 V)
3A	Can 1 - (for ECU interface)	9A	+ VB
4A	Can 1 + (for ECU interface)	10A	GND
5A	RS 232 TX (for ECU interface)	11A	+ VB
6A	RS232 RX (for ECU interface)	12A	Speed

Connector Details (AMP 16 Pins)

Pin	Function	Pin	Function
1B	Analog Input 4	9B	Analog Input 8
2B	V Reference	10B	USB D+
3B	Analog GND	11B	Analog GND
4B	Analog Input 3	12B	Analog Input 7
5B	Analog Input 2	13B	Analog Input 6
6B	V Reference	14B	V Reference
7B	Analog GND	15B	Analog GND
8B	Analog Input 1	16B	Analog Input 5



Technical characteristics

General characteristics	Value
Analog Input channels	8
Speed channels	1
Input channels from ECU	Max 64
Max Sampling frequency per channel	Up to 500 Hz
Total sampling frequency	2000 Hz
Internal g-sensor	Mono-axial, $\pm 10g$
External power	From 9 to 15 VDC
Voltage output (V reference)	4,5 V (for potentiometers)
Internal memory	8 Mbytes
ECU Interface	Serial / CAN protocol
PC Interface	300 Kbytes / sec. USB port

Other characteristics	Value
MXL Pista dimensions	174 x 110 x 26 mm
Display dimensions	140 x 67mm
Chassis	Aluminium

Appendix “G” – MXL PRO technical characteristics

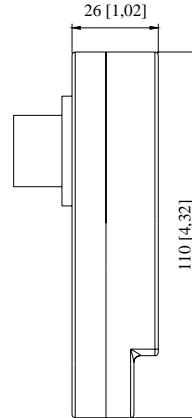
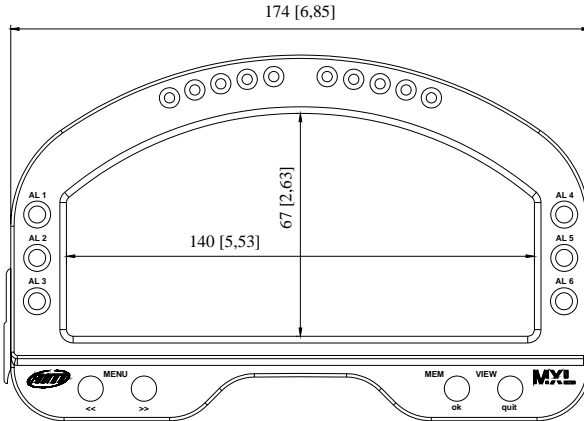

Dimensions in millimetres [inches]

**22 Pins Deutsch connector
(external view on the right)**

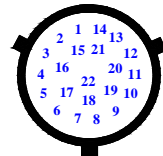

Pin	Function	Pin	Function
1	+ VB	12	GND
2	GND	13	+ VB
3	Can 0 + (Ext. expansion modules)	14	MEM
4	Can 0 - (Ext. expansion modules)	15	VIEW
5	Speed 3	16	GND
6	Speed 4	17	RS 232 RX (for ECU interface)
7	USB D-	18	RS 232 TX (for ECU interface)
8	USB D+	19	GND
9	GND	20	Can 1+ (for ECU interface)
10	+ VB	21	Can 1 - (for ECU interface)
11	GND	22	n.c.

**37 Pins Deutsch connector
(external view on the right)**

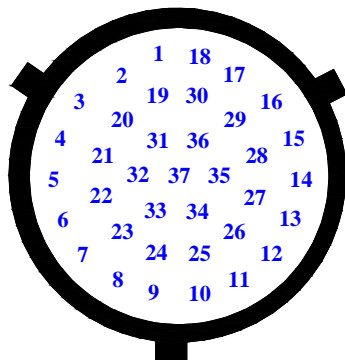

Pin	Function	Pin	Function
1	9-15 V Battery input	20	Analog GND
2	Analog Input 1	21	V reference
3	Analog Input 2	22	V reference
4	Analog GND	23	Analog GND
5	Analog GND	24	V reference
6	V reference	25	Analog GND
7	V reference	26	Analog Input 8
8	Analog Input 3	27	GND
9	Analog Input 4	28	Optic Lap
10	Analog Input 6	29	Magnetic Lap
11	Analog GND	30	Speed 2
12	RPM Square Wave 4-8 V	31	Analog GND
13	RPM Coil 150-400 V and RPM Square Wave (>8V)	32	Analog Input 5
14	+ VB	33	Analog Input 7
15	GND	34	V reference
16	+ VB	35	GND
17	+ VB	36	Speed 1
18	GND	37	GND
19	Analog GND		



Technical characteristics

General characteristics	Value
Analog Input channels	8
Speed channels	4
Input channels from ECU	Max 64
Max sampling frequency per channel	Up to 500 Hz
Total sampling frequency	2000 Hz
Internal g-sensor	Mono-axial $\pm 10g$
External power	From 9 to 15 VDC
Voltage output (V reference)	4,5 V (for potentiometers)
Internal memory	8 Mbytes
ECU interface	Serial / CAN protocol
PC Interface	300 Kbytes/ sec USB port

Other characteristics	Value
MXL PRO dimensions	174 x 110 x 26 mm
Display dimensions	140 x 67 mm
Chassis	Aluminium

Appendix “H” – MXL PRO 05 technical characteristics

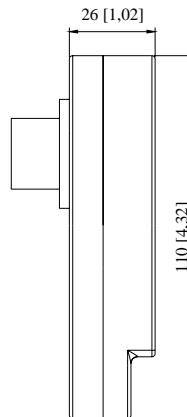
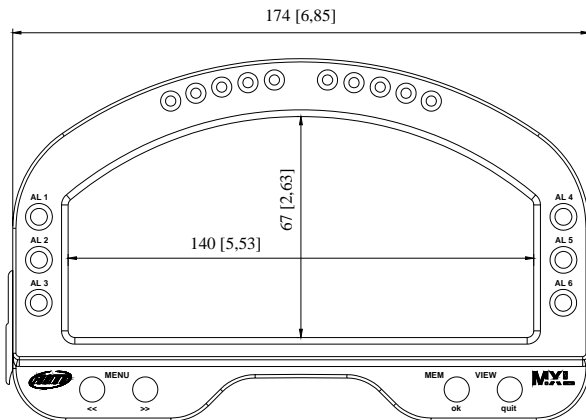

Dimensions in millimetres [inches]

**22 Pins Deutsch connector
(external view on the right)**

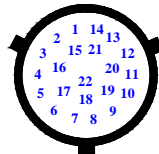

Pin	Function	Pin	Function
1	+ VB	12	GND
2	GND	13	+ VB
3	Can 0 + (Ext. expansion modules)	14	MEM
4	Can 0 - (Ext. expansion modules)	15	VIEW
5	Speed 3	16	Gear Flash
6	Speed 4	17	RS 232 RX (for ECU interface)
7	USB D-	18	RS 232 TX (for ECU interface)
8	USB D+	19	GND
9	GND	20	Can 1+ (for ECU interface)
10	+ VB	21	Can 1 - (for ECU interface)
11	GND	22	9-15 V Battery input

**37 Pins Deutsch connector
(external view on the right)**

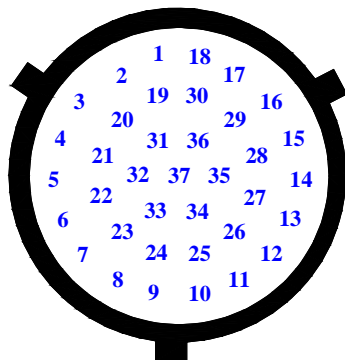

Pin	Function	Pin	Function
1	9-15 V Battery input	20	Analog Input 12
2	Analog Input 1	21	V reference
3	Analog Input 2	22	V reference
4	Analog GND	23	Analog Input 10
5	Analog GND	24	V reference
6	V reference	25	Analog Input 9
7	V reference	26	Analog Input 8
8	Analog Input 3	27	Analog GND
9	Analog Input 4	28	GND
10	Analog Input 6	29	+ VB
11	Analog GND	30	Speed 2
12	RPM Square Wave 4-8 V	31	Analog GND
13	RPM Coil 150-400 V and RPM Square Wave (>8V)	32	Analog Input 5
14	+ VB	33	Analog Input 7
15	GND	34	V reference
16	+ VB	35	Analog GND
17	+ VB	36	Speed 1
18	GND	37	Lap
19	Analog Input 11		



Technical characteristics

General characteristics	Value
Analog Input channels	12
Speed channels	4
Input channels from ECU	Max 64
Max sampling frequency per channel	Up to 500 Hz
Total sampling frequency	2000 Hz
Internal g-sensor	Mono-axial $\pm 10g$
External power	From 9 to 15 VDC
Voltage output (V reference)	4,5 V (for potentiometers)
Internal memory	16 Mbytes
ECU interface	Serial / CAN protocol
PC Interface	300 Kbytes/ sec USB port

Other characteristics	Value
MXL PRO 05 dimensions	174 x 110 x 26 mm
Display dimensions	140 x 67 mm
Chassis	Aluminium
